

**BRONCHOSCOPY /
THORACOSCOPY /
MEDIASTINOSCOPY**

BASIC SET

MINI THORASCOPY SET

FOR SINGLE-PORT TECHNOLOGY

Product	Product no.	Quantity	Catalog/Section
OR endoscope bndl consisting of:	8920.4011		Thoracoscopy
OR endoscope 0° Ø 5.5 mm SL 215 mm	8920.401	1	Thoracoscopy
Autom. sealing element ID 5.7 mm 8920.311	8920.311		Thoracoscopy
Sealing membrane Ø 17 mm (PU = 10 pcs)	89.103	1	Thoracoscopy
Sealing cap, red-orange	15176.020		Thoracoscopy
Trocar sleeve straight capacity 5.8 mm WL 62 mm	8905.331	1	Thoracoscopy
Trocar tip blunt SZ 5.5 mm WL 80 mm, tip tapered / blunt	8905.3315	1	Thoracoscopy
Trocar sleeve, straight, capacity 5.7 mm WL 60 mm	8906.051	1	Thoracoscopy
Trocar tip dull SZ 5.5 mm WL 83 mm, tip tapered / blunt	8906.151		Thoracoscopy
Double spoon forceps mono Ø 3.5 mm bndl	83912167	1	Thoracoscopy
Hook electrode mono Ø 3.5 mm WL 310 mm	8379.452	1	Laparoscopy / Electrodes
Coagulation electrode mono Ø 3.5 mm WL 310 mm	8379.462	1	Laparoscopy / Electrodes
Surgical probe 3.5 mm WL 350 mm	8379.672	1	Laparoscopy / Probes
Saugrohr AD 2,8 mm WL 450 mm	8380.68	1	Thoracoscopy
allos:			
Fiber light cable bndl	806625231	1	Thoracoscopy
Reprocessing basket	38008	1	Thoracoscopy



* Suitable pleurodesis sets are available on the market, e.g. STERITALC PF3 from Novatech

MINI THORACOSCOPE FOR SINGLE PORT TECHNOLOGY

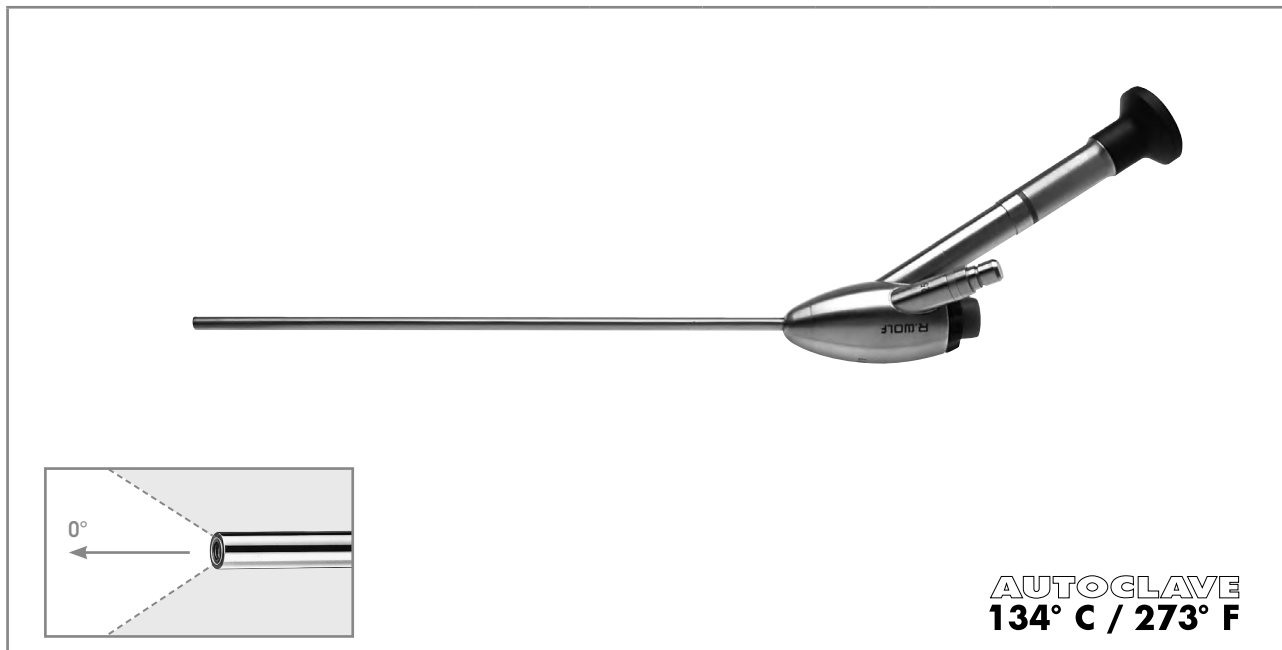
5.5 MM WITH 3.5 MM WORKING CHANNEL

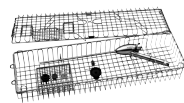

	Direction of view	SL	TL	Ø	Working channel Ø	Product no.
OR endoscope bndl consisting of: OR endoscope 0° Ø 5.5 mm SL 215 mm (8920.401) Autom. sealing element ID 5.7 mm (8920.311) Sealing cap, red-orange (15176.020) Sealing membrane Ø 17 mm (PU = 10 PCS) (89.103)	0°	215 mm	370 mm	5.5 mm	3.5 mm	8920.4011

Recommended accessories		Product no.
Trocar sleeve straight capacity 5.8 mm WL 62 mm		8905.331
also: Trocar tip blunt SZ 5.5 mm WL 80 mm tip tapered / blunt		8905.3315
Trocar sleeve, straight, capacity 5.7 mm WL 60 mm		8906.051
also: Trocar tip dull SZ 5.5 mm WL 83mm, tip tapered / blunt		8906.151
Perforated basket for telescope Dimensions (W x L x H): 132 x 467 x 75 mm		38008
Fiber light cable bndl consisting of: Fiber light cable (80663523), projector-side adapter (8095.07), and endoscope-side adapter (809509)	Ø 3.5 mm, 2.3 m long	806635231

PANOVIEW TELESCOPE Ø 4.0 mm
OPTICAL FORCEPS FOR PANOVIEW TELESCOPE

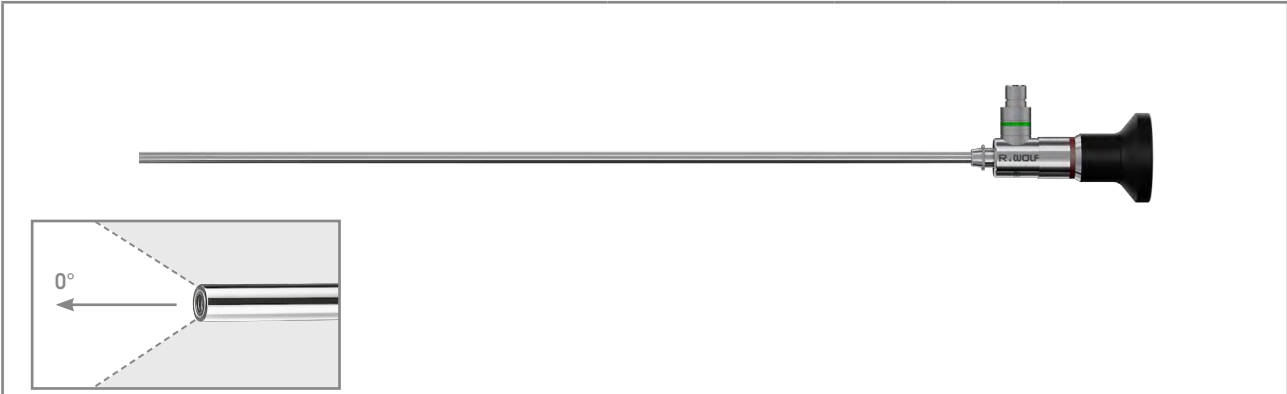

	Direction of view	WL	TL	Ø	Product no.
PANOVIEW Telescope 0° Ø 4 mm WL 289 mm	0°	298 mm	365 mm	4.0 mm	8650.414



		Outer Ø	WL	Product no.
	Opt. grasping forceps Ø 7 mm WL 281 mm smooth, with double spoon jaw	7.0 mm	281 mm	8913.60

Recommended accessories		Product no.
Perforated basket for standard telescope 2	(W x H x D) 481 x 54 x 59 mm	38016
Fiber light cable bndl consisting of: Fiber light cable (80662523), projector-side adapter (8095.07), and endoscope-side adapter (809509)	Ø 2.5 mm, 2.3 m long	806625231

Vi25 | Subject to modifications. Please note that some products may not be available in all countries. Please always take note of the information that is provided with the product. For more detailed information, please consult with your contact partner or directly with Richard Wolf GmbH.

PANOVIEW TELESCOPE Ø 5.3 MM



free of distortion

full screen

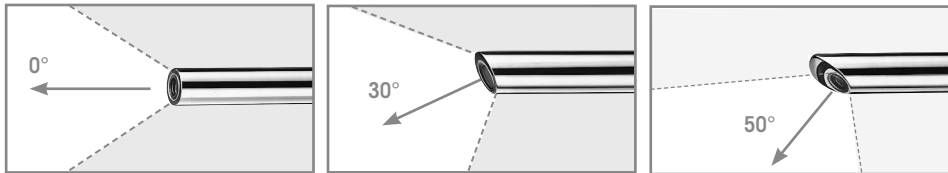
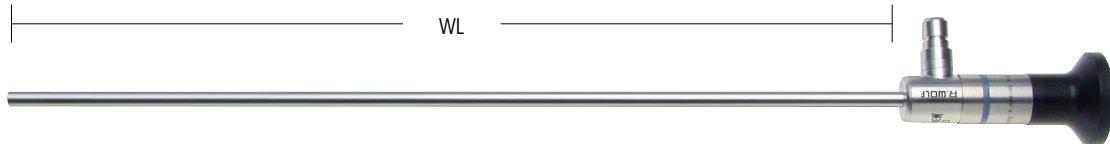

AUTOCLAVE
134° C / 273° F

	Direction of view	WL	TL	Ø	Product no.
PANOVIEW Telescope 0° Ø 5.3 mm WL 303 mm	0°	303 mm	372 mm	5.3 mm	8935.441
PANOVIEW Telescope 30° Ø 5.3 mm WL 303 mm	30°		373 mm		8935.442
PANOVIEW Telescope 50° Ø 5.3 mm WL 309 mm	50°	309 mm	377 mm		8935.443

Recommended accessories		Product no.
Perforated basket for standard telescope 2	(W x H x D) 481 x 54 x 59 mm	38016
Fiber light cable bndl consisting of: Fiber light cable (80662523), projector-side adapter (8095.07), and endoscope-side adapter (809509)	Ø 2.5 mm, 2.3 m long	806625231

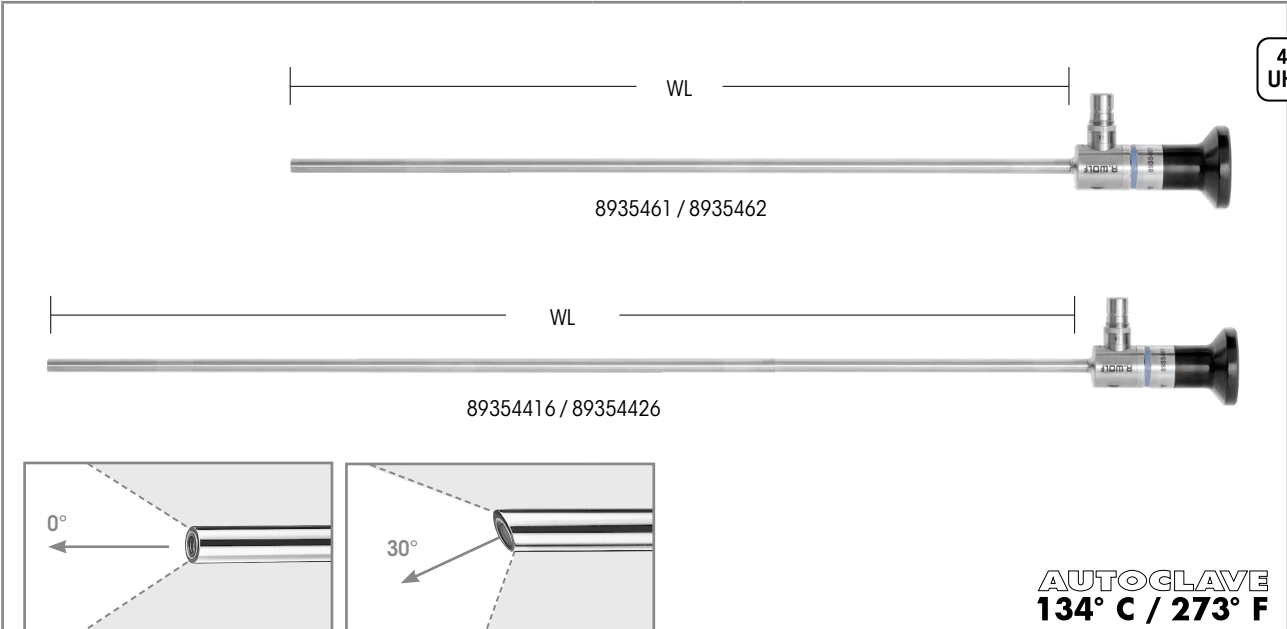

	Direction of view	WL	Ø	Product no.
PANOVIEW ULTRA Telescope Ø 5.5 mm WL 300 mm	0°	300 mm	5.5 mm	8935461
PANOVIEW ULTRA Telescope Ø 5.5 mm WL 300 mm	30°			8935462
PANOVIEW ULTRA Telescope Ø 5.5 mm WL 430 mm	0°	430 mm		89354416
PANOVIEW ULTRA Telescope Ø 5.5 mm WL 430 mm	30°			89354426

Recommended accessories		Product no.
Perforated basket for standard telescope 2 (for telescope 8935416/8935426)	(W x H x D) 481 x 54 x 59 mm	38016
Perforated basket for standard telescope 3 (for telescope 89354416/89354426)	(W x H x D) 619 x 54 x 59 mm	38017
Fiber lightcable bndl consisting of: Fiber light cable Ø 5 mm TL 2.3 m (80665023), projector-side adapter (8095.07), and endoscope-side adapter (809509)	Ø 5.0 mm, 2.3 m long	806650231
Fusion Fiber light cable bndl consisting of: Fiber light cable Ø 5 mm TL 2.3 m (80655023), projector-side adapter (8095.07), and endoscope-side adapter (809509)	Ø 5.0 mm, 2.3 m long	806550231

V125 || Subject to modifications. Please note that some products may not be available in all countries. Please always take note of the information that is provided with the product. For more detailed information, please consult with your contact partner or directly with Richard Wolf GmbH.

PANOVIEW PLUS TELESCOPE Ø 7.0 MM

‡ FREE OF DISTORTION

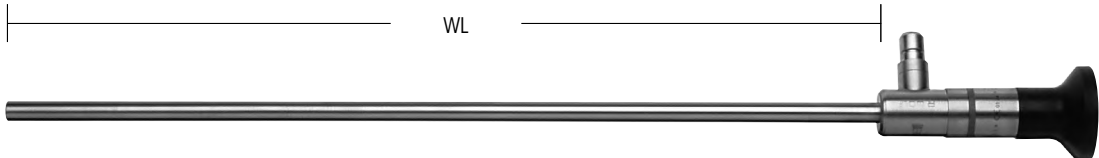

HD
High Definition

AUTOCLAVE
134° C / 273° F

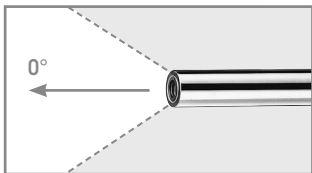
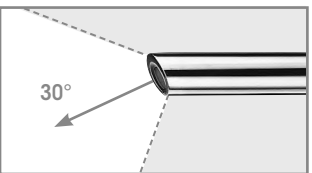
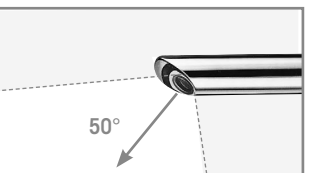
	Direction of view	WL	TL	Ø	Product no.
PANOVIEW PLUS Telescope 0° Ø 7 mm WL 297 mm	0°	297 mm	368 mm	7.0 mm	8933.431
PANOVIEW Telescope 30° Ø 7 mm WL 297 mm	30°		368 mm		8933.432
PANOVIEW Telescope 50° Ø 7 mm WL 300 mm	50°	300 mm	369 mm		8933.433

Recommended accessories	Product no.
Perforated basket for standard telescope 2	(W x H x D) 481 x 54 x 59 mm 38016
Fiber light cable bndl consisting of: Fiber light cable (80662523), projector-side adapter (8095.07), and endoscope-side adapter (809509)	Ø 2.5 mm, 2.3 m long 806625231

V125 || Subject to modifications. Please note that some products may not be available in all countries. Please always take note of the information that is provided with the product. For more detailed information, please consult with your contact partner or directly with Richard Wolf GmbH.

PANOVIEW PLUS TELESCOPE Ø 10 MM

‡ FREE OF DISTORTION

‡ free of distortion

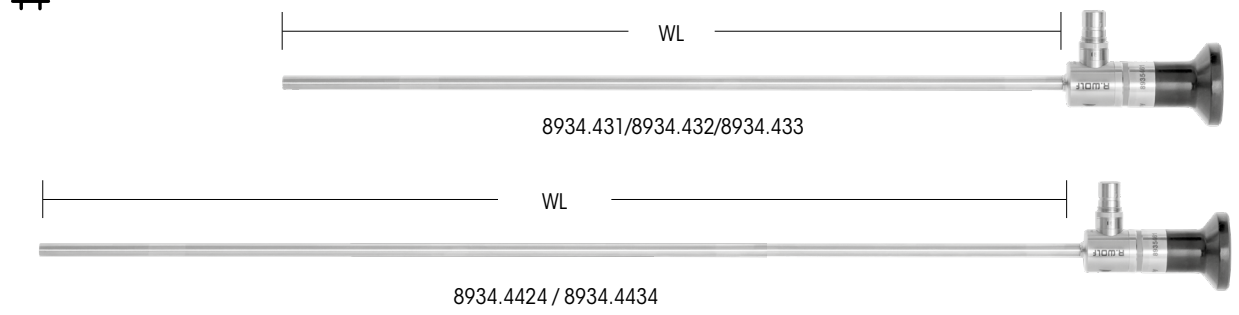
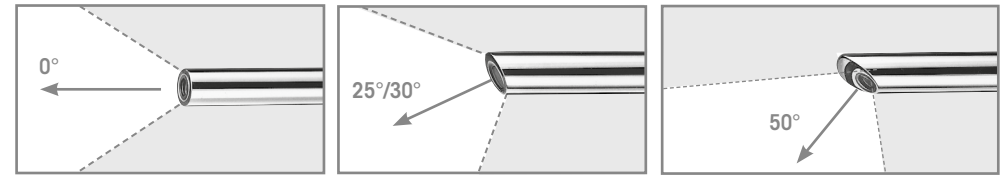



**AUTOGLAVE
134° C / 273° F**



	Direction of view	WL	TL	Ø	Product no.
PANOVIEW Telescope 0° Ø 10 mm WL 307 mm	0°	307 mm	375 mm	10 mm	8934.431
PANOVIEW Telescope 30° Ø 10 mm WL 307 mm	30°	307 mm	375 mm		8934.432
PANOVIEW Telescope 50° Ø 10 mm WL 310 mm	50°	310 mm	378 mm		8934.433
PANOVIEW PLUS Telescope 25° Ø 10 mm WL 438 mm	25°	438 mm	507 mm		8934.4424
PANOVIEW PLUS Telescope 50° Ø 10 mm WL 447 mm	50°	447 mm	516 mm		8934.4434

Recommended accessories		Product no.
Perforated basket for standard telescope 2 (for telescope 8934.431/432/433)	(W x H x D) 481 x 54 x 59 mm	38016
Perforated basket for standard telescope 3 (for telescope 8934.4424/4434)	(W x H x D) 619 x 54 x 59 mm	38017
Fiber lightcable bndl consisting of: Fiber light cable Ø 5 mm TL 2.3 m (8065023), projector-side adapter (8095.07), and endoscope-side adapter (809509)	Ø 5.0 mm, 2.3 m long	806650231
Fusion Fiber light cable bndl consisting of: Fiber light cable Ø 5 mm TL 2.3 m (80655023), projector-side adapter (8095.07), and endoscope-side adapter (809509)	Ø 5.0 mm, 2.3 m long	806550231

TROCAR SLEEVE 5.5 MM / 5.8 MM

PLASTIC WITH SEALING MEMBRANE

 <p>AUTOCLAVE 134° C / 273° F</p>					Tip tapered/blunt	Tip tapered/pointed	Tip triangular
							
					Trocar tip blunt SZ 5.5 mm	Trocar tip pointed SZ 5.5 mm	Trocar tip triangular SZ 5.5 mm
Flexible plastic sheath tube with thread	WL	Capacity	with stopcock	Product no.	WL 104 mm	WL 104 mm	WL 104 mm
Trocar sleeve straight capacity 5.5 mm WL 62 mm with membrane valve	62 mm	5.5 mm	●	8919.333	8919.3311	8919.3312	8919.3313
				8919.331			
					WL 144 mm	WL 144 mm	WL 144 mm
Trocar sleeve straight capacity 5.5 mm WL 102 mm with membrane valve	102 mm	5.5 mm	●	8919.353	8919.3511	8919.3512	8919.3513
				8919.351			







for curved instruments				Tip tapered/blunt	Tip tapered/pointed	Tip triangular	Tip tapered/blunt
 <p>AUTOCLAVE 134° C / 273° F</p>							
				Trocar tip blunt SZ 5.5 mm	Trocar tip pointed SZ 5.5 mm	Trocar tip triangular SZ 5.5 mm	Trocar tip blunt SZ 5.5 mm
Flexible plastic sheath tube, with thread	WL	Capacity	Product no.	WL 80 mm	WL 80 mm	WL 80 mm	WL 80 mm
Trocar sleeve straight capacity 5.8 mm WL 62 mm with membrane valve	62 mm	5.8 mm	8905.331	8905.3311	8905.3312	8905.3313	8905.3315
				WL 120 mm	WL 120 mm	WL 120 mm	WL 120 mm
Trocar sleeve straight capacity 5.8 mm WL 102 mm with membrane valve	102 mm	5.8 mm	8905.351	8905.3511	8905.3512	8905.3513	8905.3515

Accessories	Product no.
Sealing membrane Ø 17 mm, yellow (PU = 10 PCS)	89.103
Stopcock insert bndl cap 3.0 mm (PU = 5 PCS)	896.0002



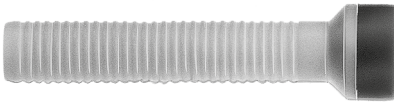





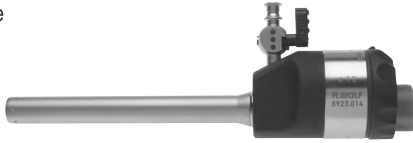

TROCAR SLEEVE 5.7 MM/7 MM/10 MM/12,5 MM

FLEXIBLE PLASTIC SHEATH TUBE

TROCAR SLEEVE 13,6 MM STAINLESS STEEL SHEATH TUBE

				Tip tapered/blunt	
				Trocar tip blunt	
Flexible plastic sheath tube with thread	WL	Capacity	Product no.	Size 5.5 mm/WL 83 mm	
Trocar sleeve, straight, capacity 5.7 mm WL 60 mm with rubber cap	60 mm	5.7 mm	8906.051	8906.151	
				Tip tapered/blunt	
				Trocar tip blunt	
Ribbed flexible plastic sheath tube	WL	Capacity	Product no.	Size 7.3 mm/TL 108 mm	
Trocar sleeve flexible capacity 7 mm WL 74 mm with universal seal	74 mm	7 mm	8906.001	8913.11	
				Size 10 mm/TL 85 mm	
Trocar sleeve flexible capacity 10 mm WL 56 mm with universal seal	56 mm	10 mm	8906.011	8906.111	
				Size 12.5 mm/TL 86 mm	
Trocar sleeve flexible capacity 12.5 mm WL 57 mm with universal seal	57 mm	12.5 mm	8906.031	8906.131	
				Tip, semi-blunt	
				Trocar tip blunt SZ 13.5 x 18 mm	
Stainless steel sheath tube	WL	Capacity	Product no.	TL 78 mm	
Trocar sleeve cap 13.6 x 18 mm WL 56 mm	56 mm	13.6 x 18 mm	8906.081	8906.181	

TROCAR SLEEVE 10 MM WITH INSUFFLATION STOPCOCK

RIWO-ART trocar sleeves with magnetic ball valve 					Tip tapered/blunt	Tip tapered/pointed	Tip triangular
					 Trocar tip blunt SZ 10 mm	 Trocar tip pointed SZ 10 mm	 Trocar tip triangular SZ 10 mm
Stainless steel sheath tube		WL	Capacity	Product no.	WL 164 mm	WL 164 mm	WL 164 mm
Trocar sleeve straight capacity 10 mm WL 100 mm 	100 mm	10 mm	8923.014	8923.103	8923.113	8923.123	
Trocar sleeve slanted capacity 10 mm WL 100 mm 	100 mm	10 mm	8923.013	8923.103	8923.113	8923.123	
Trocar sleeve straight capacity 10 mm WL 100 mm with thread 	100 mm	10 mm	8923.024	8923.103	8923.113	8923.123	
Trocar sleeve slanted capacity 10 mm WL 100 mm with thread 	100 mm	10 mm	8923.023	8923.103	8923.113	8923.123	
					WL 214 mm	WL 214 mm	WL 214 mm
Trocar sleeve straight capacity 10 mm WL 150 mm 	150 mm	10 mm	8923.016	-	8923.115	8923.125	
Trocar sleeve straight capacity 10 mm WL 150 mm with thread 	150 mm	10 mm	8923.026	-	8923.115	8923.125	

Accessories	Product no.
Spare ball capacity 7 mm	8923.901
Spare O-rings capacity 7 mm (PU = 10 PCS), capacity Ø 7–12.5 mm	8923.951
Sealing cap capacity 9.5–10.1 mm (PU = 10 PCS) red	89.08
Stopcock insert bndl cap. 3.0 mm (PU = 5 PCS)	896.0002

SURGICAL PROBES

SURGICAL PROBES



		Ø	WL	Product no.
	Surgical probe 3.5 mm WL 350 mm graduated	3.5 mm	350 mm	8379.672



		Ø	WL	Product no.
	Surgical probe Ø 5 mm WL 328 mm graduated	5.0 mm	328 mm	8383.66
	Surgical probe Ø 5 mm WL 448 mm graduated	5.0 mm	448 mm	8384.66





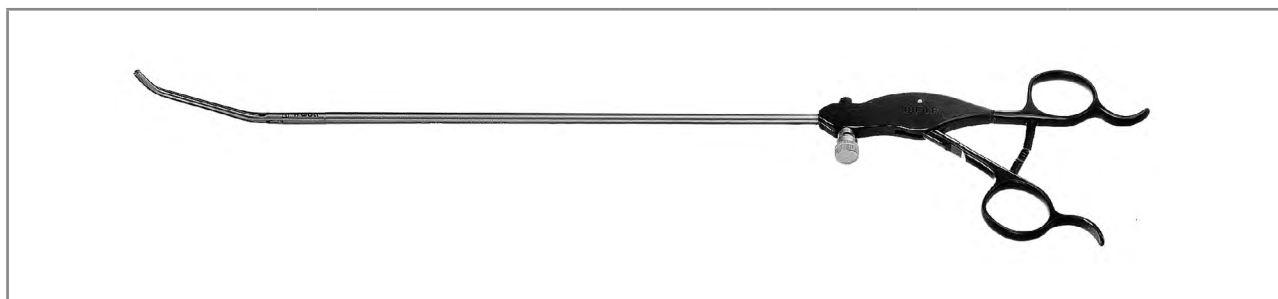

VI25 || Subject to modifications. Please note that some products may not be available in all countries. Please always take note of the information that is provided with the product. For more detailed information, please consult with your contact partner or directly with Richard Wolf GmbH.

VESSEL CLAMP / PARENCHYMA FORCEPS 5 MM

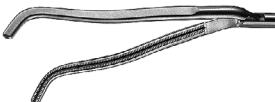
LUNG GRASPING FORCEPS 5 MM

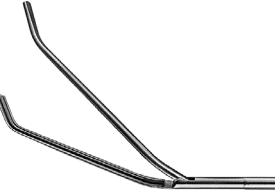

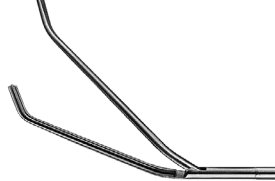
LINDNER



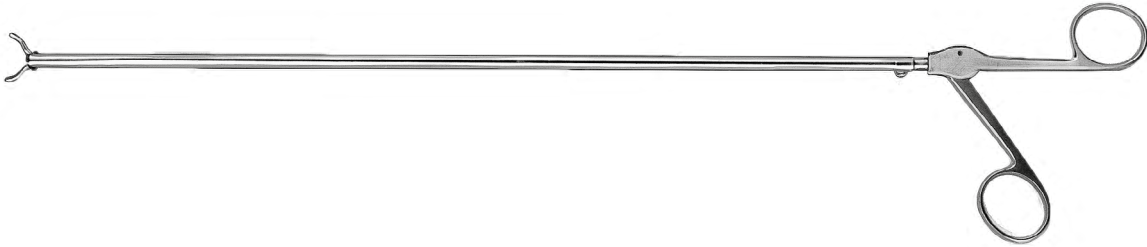

with irrigation connector		Ø	WL	TL	Product no.
	Dimensions: Ø 5 mm jaw section curved to the left	5 mm	260 mm	415 mm	8242.651
	Dimensions: Ø 5 mm jaw section curved to the right				8242.652
	Parenchyma forceps Ø 5 mm WL 270 mm 30 mm curved to the left	5 mm	270 mm	402 mm	8242.601
	Parenchyma forceps Ø 5 mm WL 270 mm 30 mm curved to the right				8242.602
	Parenchyma forceps Ø 5 mm WL 280 mm 50 mm curved to the left	5 mm	280 mm	412 mm	8242.603
	Parenchyma forceps Ø 5 mm WL 280 mm jaw section curved to the right				8242.604
	Lung grasping forceps WL 270 mm angled	5 mm	270 mm	402 mm	8242.611

PARENCHYM GRASPING FORCEPS 7MM
BYPASS FORCEPS 7 MM





		Ø	WL	TL	Product no.
	Parenchym grasping forceps Ø 7 mm WL 270 mm straight	7 mm	270 mm	402 mm	8243.603
	Parenchym grasping forceps Ø 7 mm WL 264 mm curved	7 mm	264 mm	396 mm	8243.604





with irrigation connection		Ø	WL	TL	Product no.
	Bypass forceps Ø 7 mm WL 400 mm jaw left curved	7 mm	400 mm	532 mm	8243.711

SCISSORS / TISSUE RETRACTORS

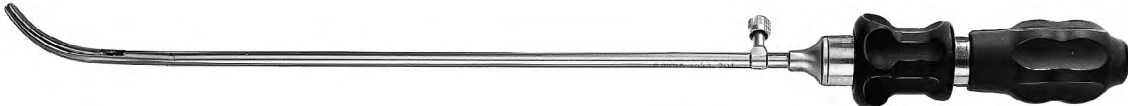

with irrigation connector		Ø	WL	TL	Product no.
 Jaw section straight, sheath straight, single opening	Scissors Ø 6.5 mm WL 260 mm	6.5 mm	260 mm	392 mm	8243.403
 Jaw section curved, sheath straight, single opening	Scissors curved Ø 7 mm WL 260 mm	7.0 mm	260 mm	392 mm	8243.404



with irrigation connector		Ø	WL	TL	Product no.
 Jaw section curved downward, sheath straight	Tissue retractor Ø 6.5 mm WL 330 mm	6.5 mm	330 mm	492 mm	8243.701

ERAGON^{modular}





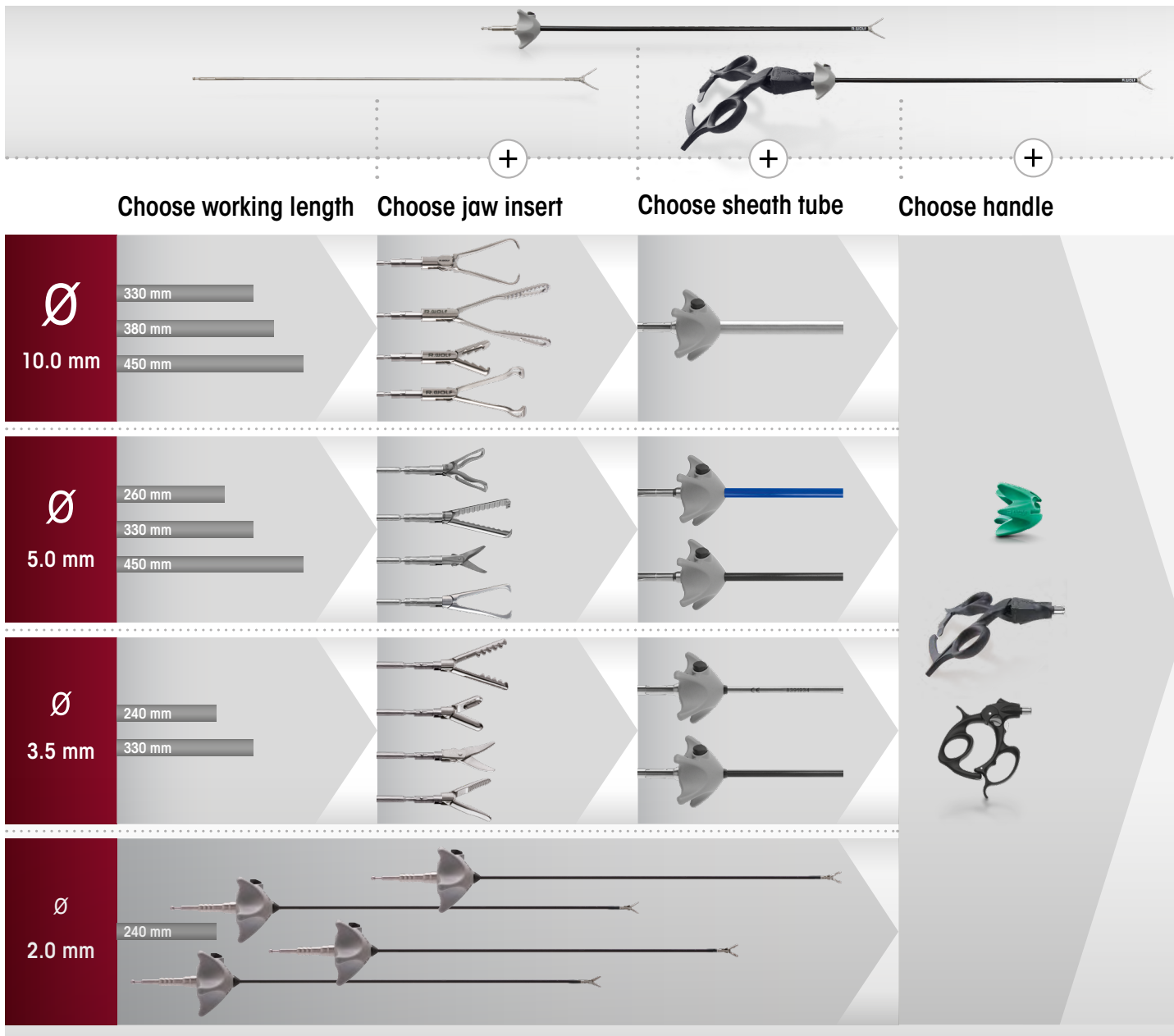

THE LAPAROSCOPIC TOOLBOX

The toolbox principle

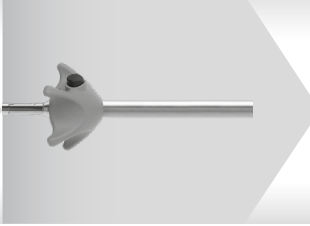
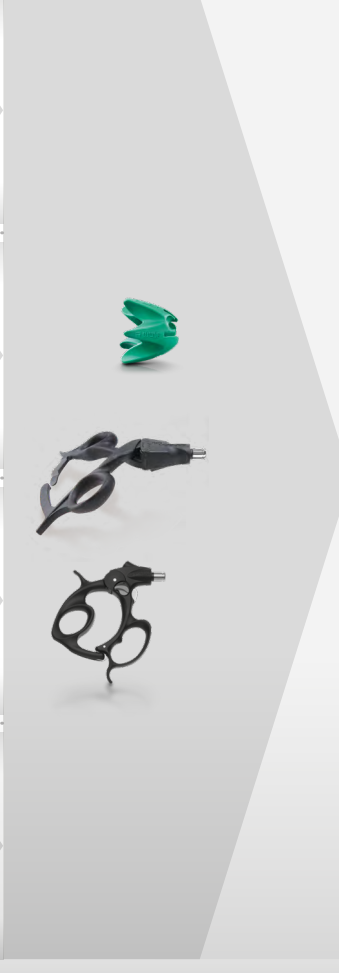
ERAGONmodular offers surgeons every possible way of creating their dream set of laparoscopic instruments. Ergonomic handles, all practical diameters, useful working lengths, and a diverse range of jaw parts can be combined in any configuration. This universal compatibility also ensures that individual trays can comprise just a few instruments – for more efficiency and one way of cutting costs.

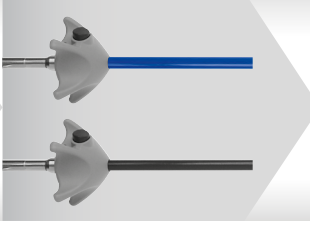

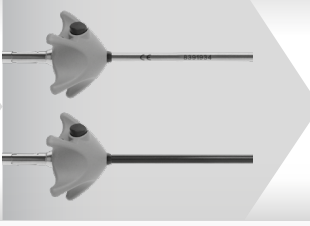
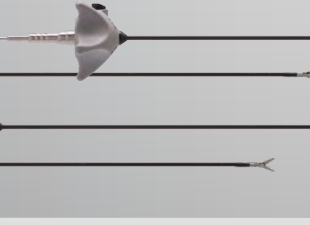
The diagram illustrates the modular assembly of a laparoscopic instrument. It shows four main components: working length, jaw insert, sheath tube, and handle, which are combined to form a complete instrument. Below this, a grid shows various options for each component based on diameter (10.0 mm, 5.0 mm, 3.5 mm, 2.0 mm).

	Choose working length	Choose jaw insert	Choose sheath tube	Choose handle
10.0 mm	330 mm 380 mm 450 mm			
5.0 mm	260 mm 330 mm 450 mm			
3.5 mm	240 mm 330 mm			
2.0 mm	240 mm			

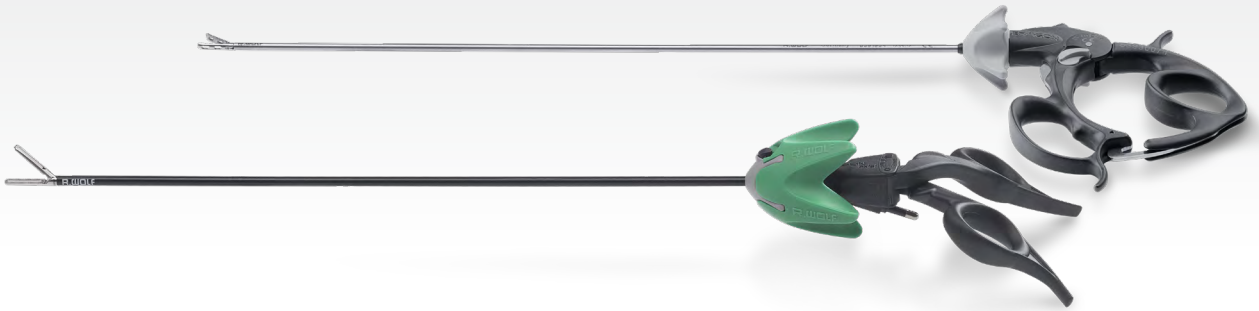

Complete instrument/tray

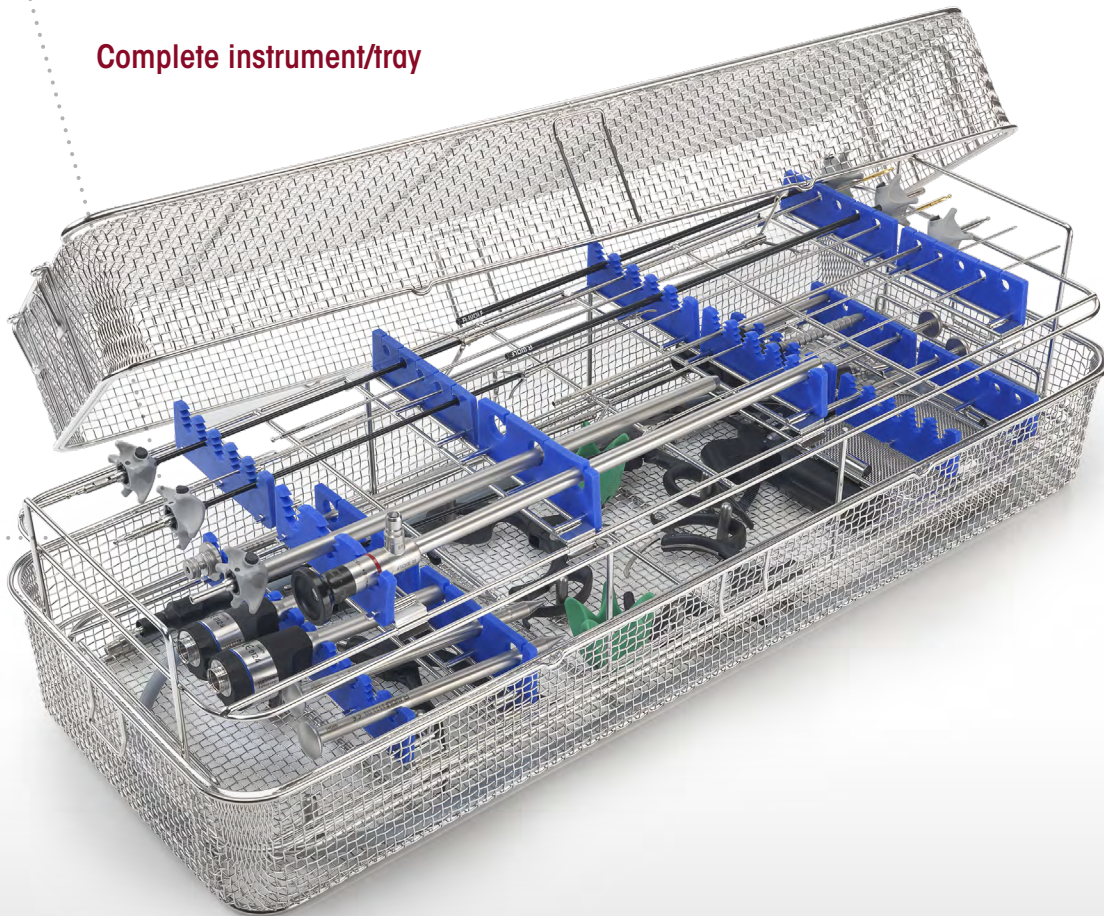

ERAGON modular

THE ERGONOMIC GENERATION OF NEEDLE HOLDERS

Thanks to the custom combination options it offers, **ERAGONstitch** can accommodate any user requirement. The way in which it brings together ergonomics, versatility, modularity, and precision sets new standards in comfort.

ERAGONMODULAR

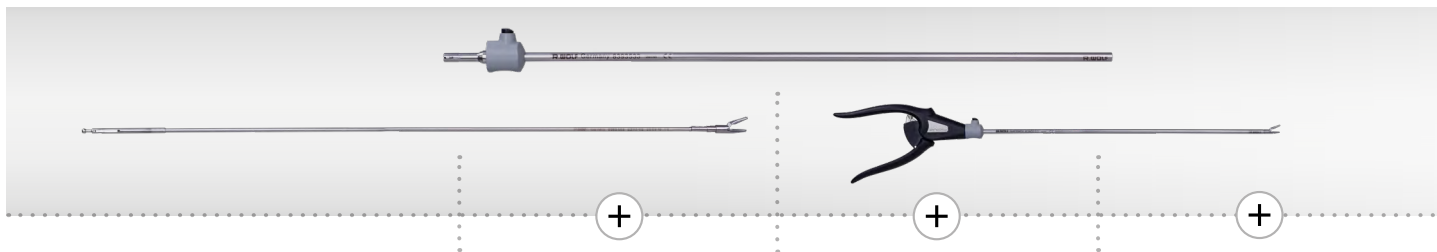

Choose working length

Choose jaw insert

Choose sheath tube

Choose handle

<p>3.5</p> <p>Ø 5.0 mm</p>	<p>330 mm</p> <p>450 mm</p>			
	<p>Ø 3.5 mm</p> <p>240 mm</p> <p>330 mm</p>			









ERAGONstitch needle holders



ERAGON modular
micro
Ø 2 MM, INSULATED





ERAGONMODULAR

3.5

		Handle, axial			
ERAGON axial					
All jaw inserts and sheath tubes can also be combined with ERAGON axial.		without lock, with HF connector	without lock, with HF connector		
Rotatable knob	Product no.	83930083	83930084		
	8988	.	.		
Jaw insert		Sheath tube, Ø 2.0 mm, insulated	Handle, pistol-shaped	Complete instrument	
				<ul style="list-style-type: none"> • Jaw insert with sheath tube • Handle 	
		WL 240 mm	without lock, with HF, mono		
	JL*	Product no.	83930073	Product no.	
	7 mm	8388200	.	.	83882007
straight, double-action					
	7 mm	8388201	.	.	83882017
straight, double-action					
	7 mm	8388202	.	.	83882027
fenestrated, double-action					

* JL = jaw length when jaw section closed (approximate measurements)
HF connection cable: see page THORAX107/108

ERAGON *modular*
micro
Ø 2 MM, INSULATED

Jaw insert		Sheath tube, Ø 2.0 mm, insulated		Handle, pistol-shaped	Complete instrument • Jaw insert with sheath tube • Handle
					
		WL 240 mm		with lock, with HF, mono	
	JL*	Product no.		83930074	Product no.
 Grasping forceps mono Ø 2 mm bndl double-action	7 mm	8388203	•	•	83882037

* JL = jaw length when jaw section closed (approximate measurements)
HF connection cable: see page THORAX107/108





Accessories for manual and machine reprocessing		Product no.
	Irrigation adapter Ø 9 mm, length 64 mm	163502







ERAGON modular mini

Ø 3.5 MM, INSULATED

ERAGONMODULAR

3.5

		Handle, axial	
 All jaw inserts and sheath tubes can also be combined with ERAGONaxial.			
		without lock, with HF connector	without lock, with HF connector
Rotatable knob	Product no.	83930083	83930084
	8988	.	.

Jaw insert		Sheath tube, Ø 3.5 mm, insulated		Handle, pistol-shaped	Complete instrument
 JL		WL 240 mm	WL 330 mm	 with lock, with HF, mono	• Jaw insert with sheath tube • Handle
		Product no.	8390933		8391933
 15 mm	Dissector forceps mono Ø 3.5 mm bndl curved to the left, double-action	8390207	.	.	83902077
		8391207	.	.	83912077
 18 mm	Dissector forceps mono Ø 3.5 mm bndl long, fine tip, double-action	8390221	.	.	83902217
		8391221	.	.	83912217
 14 mm	Dissector forceps mono Ø 3.5 mm bndl short, fine tip, double-action	8390222	.	.	83902227
		8391222	.	.	83912227
 14 mm	Dissector forceps mono Ø 3.5 mm bndl angled, double-action	8390223	.	.	83902237
		8391223	.	.	83912237









* JL = jaw length when jaw section closed (approximate measurements)

HF connection cable: see page THORAX107/108

V125 | Subject to modifications. Please note that some products may not be available in all countries. Please always take note of the information that is provided with the product. For more detailed information, please consult with your contact partner or directly with Richard Wolf GmbH.

ERAGON modular mini

Ø 3.5 MM, INSULATED

Jaw insert			Sheath tube, Ø 3.5 mm, insulated		Handle, pistol-shaped		Complete instrument • Jaw insert with sheath tube • Handle
							
							WL 240 mm
	JL*	Product no.	8390933	8391933	83930073	83930074	Product no.
 Metzenbaum scissors mono Ø 3.5 mm bndl double-action	16 mm	8390215	•		•		83902157
		8391215			•		83912157
 Metzenbaum scissors mono Ø 3.5 mm bndl fine-toothed, curved, double-action	14 mm	8390224	•		•		83902247
		8391224			•		83912247
 Hook scissors mono Ø 3.5 mm bndl single-action	8 mm	8390227	•		•		83902277
		8391227			•		83912277
 Double spoon forceps mono Ø 3.5 mm bndl	12 mm	8390216	•			•	83902167
		8391216			•		83912167
 Friedel punch mono Ø 3.5 mm bndl	10 mm	8390217	•			•	83902177
		8391217			•		83912177

* JL = jaw length when jaw section closed (approximate measurements)



HF connection cable: see page THORAX107/108







Accessories for manual and machine reprocessing		Product no.
	Irrigation adapter Ø 9 mm, length 64 mm	163502

ERAGON modular mini
Ø 3.5 MM, UNINSULATED

ERAGONMODULAR

3.5

		Handle, axial	
ERAGON axial			
All jaw inserts and sheath tubes can also be combined with ERAGON axial.		with lock, without HF connector	with lock, without HF connector, not rotatable
Rotatable knob	Product no.	83930082	83930085
	8988	.	.







Jaw insert		Sheath tube, Ø 3.5 mm, uninsulated		Handle, pistol-shaped	Complete instrument
					<ul style="list-style-type: none"> • Jaw insert with sheath tube • Handle
	JL*	WL 240 mm	WL 330 mm	with lock, without HF	
	Product no.	8390934	8391934	83930072	Product no.
	14 mm	.	.	.	83902087
fenestrated, double-action		8391208	.	.	83912087
	17 mm	.	.	.	83902187
fenestrated, single-action		8391218	.	.	83912187
	17 mm	.	.	.	83902257
double fenestrated, curved, single-action		8391225	.	.	83912257
	19 mm	.	.	.	83902267
fenestrated, double-action		8391226	.	.	83912267

* JL = jaw length when jaw section closed (approximate measurements)

HF connection cable: see page Thorax107-108

Vi25 || Subject to modifications. Please note that some products may not be available in all countries. Please always take note of the information that is provided with the product. For more detailed information, please consult with your contact partner or directly with Richard Wolf GmbH.

ERAGON modular
mini
Ø 3.5 MM, UNINSULATED







Jaw insert			Sheath tube, Ø 3.5 mm, uninsulated		Handle, pistol-shaped	Complete instrument • Jaw insert with sheath tube • Handle
						with lock, without HF
			WL 240 mm	WL 330 mm		
	JL*	Product no.	8390934	8391934	83930072	Product no.
 <p>Grasping forceps Ø 3.5 mm bndl</p>	13 mm	8390219	•		•	83902197
		fenestrated, double-action	8391219		•	•
 <p>Grasping forceps Ø 3.5 mm bndl</p>	17 mm	8390220	•		•	83902207
		fenestrated, single-action	8391220		•	•
 <p>Universal grasping forceps Ø 3.5 mm bndl</p>	14 mm	8390209	•		•	83902097
		double-action	8391209		•	•
 <p>Babcock forceps Ø 3.5 mm bndl</p>	19 mm	8390210	•		•	83902107
		double-action	8391210		•	•







* JL = jaw length when jaw section closed (approximate measurements)

HF connection cable: see page THORAX107/108

Accessories for manual and machine reprocessing		Product no.
	Irrigation adapter Ø 9 mm, length 64 mm	163503

ERAGON^{modular}
 Ø 5.0 MM, INSULATED









		Handle, axial			
 All jaw inserts and sheath tubes can also be combined with ERAGONaxial.					
		with lock	without lock, with HF connector	without lock, with HF connector	with lock, not rotatable
Rotatable knob	Product no.	83930082	83930083	83930084	83930085
	8988	•	•	•	

Jaw insert		Sheath tube, Ø 5.0 mm, insulated		Handle, pistol-shaped	Complete instrument	
					• Jaw insert with sheath tube • Handle	
	JL*	Product no.	SL 330 mm	SL 450 mm	with lock, with HF, mono	Product no.
 Maryland dissector forceps mono Ø 5 mm bndl curved, with fine cross toothing, double-action	21 mm	8393.281	•		•	83932817
		8394.281		•		83942817
 Mixer dissector forceps mono Ø 5 mm bndl angled, fine, pyramid-shaped toothing, double-action	22 mm	8393.283	•		•	83932837
 Grasping forceps, mono Ø 5 mm bndl fenestrated, with fine cross toothing, 15 mm long, single-action	21 mm	8393.185	•		•	83931857
 Grasping forceps, mono Ø 5 mm bndl fenestrated, with fine cross toothing, 20 mm long, single-action	26 mm	8393.184	•		•	83931847
		8394.184		•		83941847

* JL = jaw length when jaw section closed (approximate measurements)
 HF connection cable: see page THORAX107/108

ERAGON modular





Ø 5.0 MM, INSULATED







Jaw insert			Sheath tube, Ø 5.0 mm, insulated			Handle, pistol-shaped			Complete instrument • Jaw insert with sheath tube • Handle
									
			SL 260 mm	SL 330 mm	SL 450 mm	with lock, without HF	without lock, with HF, mono	with lock, with HF, mono	Product no.
 Dolphin dissector forceps mono Ø 5 mm bndl angled, with fine cross-toothing, with channel, narrow, 15 mm long, double-action	17 mm	8393.285		•			•		83932857
 Dissector forceps mono Ø 5 mm bndl fine pyramid-shaped toothing, narrow, 18 mm, double-action	23 mm	8393.289		•				•	83932897
 Atraumat. grasping forceps Ø 5 mm bndl Channel with wavy tooth edge, 20 mm, single-action	26 mm	8393.292		•			•		83932925
 Atraumat. grasping forceps Ø 5 mm bndl Channel with wavy tooth edge, 20 mm, double-action	26 mm	8393.293		•			•		83932935
		8394.293			•		•		83942935
 Grasping forceps, mono Ø 5 mm bndl fine, pyramid-shaped toothing, narrow double-action	19 mm	8393.288		•				•	83932887
 Atraumat. grasping forceps mono Ø 5 mm bndl fenestrated, with cross toothing, double-action	19 mm	8392.181	•					•	83921817
		8393.181		•				•	83931817
		8394.181			•			•	83941817

* JL = jaw length when jaw section closed (approximate measurements)

HF connection cable: see page THORAX107/108

ERAGON^{modular}
 Ø 5.0 MM, INSULATED









		Handle, axial			
ERAGON^{axial}					
All jaw inserts and sheath tubes can also be combined with ERAGON ^{axial} .		with lock	without lock, with HF connector	without lock, with HF connector	with lock, not rotatable
Rotatable knob	Product no.	83930082	83930083	83930084	83930085
	8988	•	•	•	

Jaw insert		Sheath tube, Ø 5.0 mm, insulated		Handle, pistol-shaped		Complete instrument	
						<ul style="list-style-type: none"> • Jaw insert with sheath tube • Handle 	
	JL*	Product no.	SL 330 mm	SL 450 mm	with lock, without HF	without lock, with HF, mono	Product no.
	18 mm	8393.195	•			•	83931957
smooth, double-action		8394.195		•		•	83941957
	24 mm	8393.186	•			•	83931867
Gripping surface with fine cross tothing, double-action							
	26 mm	8393.187	•			•	83931877
large distal gripping surface with fine cross tothing, double-action		8394.187		•		•	83941877
	39 mm	8393190	•			•	83931907
atraumatic clamp, double-action							

* JL = jaw length when jaw section closed (approximate measurements)
 HF connection cable: see page THORAX107/108

ERAGON modular





Ø 5.0 MM, INSULATED









Jaw insert			Sheath tube, Ø 5.0 mm, insulated		Handle, pistol-shaped		Complete instrument • Jaw insert with sheath tube • Handle
							
			SL 330 mm	SL 450 mm	with lock, without HF	with lock, with HF, mono	
	JL*	Product no.	8393933	8394933	83930072	83930074	Product no.
 Debakey forceps Ø 5 mm bndl atraumatic clamp, double-action	48 mm	8393191	•		•		83931917
 Grasping forceps, mono Ø 5 mm bndl with row of teeth, double-action	17 mm	8393.485	•			•	83934857
 Grasping forceps, mono Ø 5 mm bndl with one tooth, fine cross tooth- ing, narrow, double-action	19 mm	8393.486	•			•	83934867
 Grasping forceps, mono Ø 5 mm bndl with two teeth, fine cross toothing, single-action	17 mm	8393.487	•			•	83934877
 Grasping forceps Ø 5 mm bndl with two teeth wavy gripping surface, dou- ble-action	26 mm	8393.490	•		•		83934907
		8394.490		•	•		83944907
 Petelin dissector forceps mono Ø 5 mm bndl angled 30° to the left, with cross toothing, single-action	17 mm	8393.282	•			•	83932827

* JL = jaw length when jaw section closed (approximate measurements)

HF connection cable: see page THORAX107/108

ERAGON^{modular}
 Ø 5.0 MM, INSULATED







		Handle, axial			
ERAGON^{axial}					
All jaw inserts and sheath tubes can also be combined with ERAGON ^{axial} .		with lock	without lock, with HF connector	without lock, with HF connector	with lock, not rotatable
Rotatable knob	Product no.	83930082	83930083	83930084	83930085
	8988	•	•	•	

Jaw insert		Sheath tube, Ø 5.0 mm, insulated		Handle, pistol-shaped			Complete instrument
							<ul style="list-style-type: none"> • Jaw insert with sheath tube • Handle
	JL*	Product no.	8393933	with lock, without HF	without lock, with HF, mono	with lock, with HF, mono	Product no.
	18 mm	8393.182	•			•	83931827
Plate-shaped grasping forceps mono Ø 5 mm bndl fenestrated with fine cross tooting, double-action							
	21 mm	8393.183	•		•		83931837
Grasping forceps mono Ø 5 mm bndl with cross tooting, double-action							
	15 mm	8393.287	•		•		83932877
Grasping forceps mono Ø 5 mm bndl distal cross tooting with channel, double-action							
	27 mm	8393.494	•	•			83934945
Claw grasping forceps Ø 5 mm bndl double-action							

* JL = jaw length when jaw section closed (approximate measurements)
 HF connection cable: see page THORAX107/108

ERAGON modular

Ø 5.0 MM, INSULATED





Jaw insert			Sheath tube, Ø 5.0 mm, insulated		Handle, pistol-shaped			Complete instrument • Jaw insert with sheath tube • Handle
			SL 330 mm	SL 450 mm	with lock, without HF	without lock, with HF, mono	with lock, with HF, mono	
	JL*	Product no.	8393933	8394933	83930072	83930073	83930074	Product no.
 Myoma grasping forceps Ø 5 mm bndl	29 mm	8393.488	•		•			83934887
2x3-claw, single-action								
 Universal grasping forceps mono Ø 5 mm bndl	18 mm	8393.481	•				•	83934817
with pyramid-shaped toothing and cross toothing, double-action								
 Universal grasping forceps Ø 5 mm bndl	26 mm	8393.482	•		•			83934827
pyramid-shaped toothing and cross toothing, double-action								
 Grasping forceps mono Ø 5 mm bndl	20 mm	8393.483	•				•	83934837
Pike-mouth, double-action								
 Biopsy forceps mono Ø 5 mm bndl	13 mm	8393.091	•			•		83930917
with spikes, double-action		8394.091		•		•		83940917
 Biopsy forceps mono Ø 5 mm bndl	14 mm	8393.092	•			•		83930927
severing, single-action		8394.092		•		•		83940927







* JL = jaw length when jaw section closed (approximate measurements)

HF connection cable: see page THORAX107/108

V125 || Subject to modifications. Please note that some products may not be available in all countries. Please always take note of the information that is provided with the product. For more detailed information, please consult with your contact partner or directly with Richard Wolf GmbH.

ERAGON_{modular}
 Ø 5.0 MM, INSULATED

		Handle, axial			
ERAGON_{axial}					
All jaw inserts and sheath tubes can also be combined with ERAGON _{axial} .		with lock	without lock, with HF connector	without lock, with HF connector	with lock, not rotatable
Rotatable knob	Product no.	83930082	83930083	83930084	83930085
	8988	•	•	•	

Jaw insert		Sheath tube, Ø 5.0 mm, insulated		Handle, pistol-shaped		Complete instrument	
						• Jaw insert with sheath tube • Handle	
JL		SL 330 mm	SL 450 mm	with lock, without HF	without lock, with HF, mono		
	JL*	Product no.	8393933	8394933	83930072	83930073	Product no.
	20 mm	8393.093	•			•	83930937
pointed spoon forceps, single-action							
	17 mm	8393.345	•			•	83933457
with distal recess, double-action		8394.345		•			83943457
	37 mm	8393.188	•			•	83931887
spring jaw sections fenestrated with cross toothing, double-action							
	47 mm	8393.189	•			•	83931897
spring jaw sections fenestrated with cross toothing, double-action		8394.189		•		•	83941897

* JL = jaw length when jaw section closed (approximate measurements)
 HF connection cable: see page THORAX107/108







V125 | Subject to modifications. Please note that some products may not be available in all countries. Please always take note of the information that is provided with the product. For more detailed information, please consult with your contact partner or directly with Richard Wolf GmbH.

ERAGONMODULAR

3.5

ERAGON modular

Ø 5.0 MM, INSULATED

Jaw insert			Sheath tube, Ø 5.0 mm, insulated		Handle, pistol-shaped		Complete instrument • Jaw insert with sheath tube • Handle
			SL 330 mm	SL 450 mm	with lock, without HF	with lock, with HF, mono	
	JL*	Product no.	8393933	8394933	83930072	83930074	Product no.
 Debaquey forceps Ø 5 mm bndl atraumatic, spring jaws with cross toothing, double-action	47 mm	8393.291	•		•		83932917
 Dissector forceps mono Ø 5 mm bndl angled, double-action	18 mm	8393192	•			•	83931927
		8394192		•		•	83941927
 Grasping forceps, mono Ø 5 mm bndl double-action	16 mm	8393193	•		•		83931937
		8394193		•	•		83941937
 Dissector forceps mono Ø 5 mm bndl double-action	24 mm	8393194	•			•	83931947
		8394194		•		•	83941947
 Dissector forceps mono Ø 5 mm bndl double-action	30 mm	8393197	•			•	83931977
		8394197		•		•	83941977
 Dissector forceps mono Ø 5 mm bndl fine tips double-action	33 mm	8393198	•			•	83931987
		8394198		•		•	83941987





* JL = jaw length when jaw section closed (approximate measurements)







HF connection cable: see page THORAX107/108

ERAGON^{modular}
 Ø 5.0 MM, INSULATED

ERAGONMODULAR

3.5

		Handle, axial			
ERAGON^{axial}					
All jaw inserts and sheath tubes can also be combined with ERAGON ^{axial} .		with lock	without lock, with HF connector	without lock, with HF connector	with lock, not rotatable
Rotatable knob	Product no.	83930082	83930083	83930084	83930085
	8988	•	•	•	







Jaw insert		Sheath tube, Ø 5.0 mm, insulated		Handle, pistol-shaped	Complete instrument
					<ul style="list-style-type: none"> • Jaw insert with sheath tube • Handle
	JL*	SL 330 mm	SL 450 mm	with lock, with HF, mono	
	Product no.	8393933	8394933	83930074	Product no.
	32 mm	8393199	•	•	83931997
double-action		8394199	•	•	83941997
	19 mm	8393200	•	•	83932007
fine tip, double-action		8394200	•	•	83942007
	16 mm	8393210	•	•	83932107
atraumatic, with cross toothing, double-action					
	19 mm	8393220	•	•	83932207
atraumatic, with cross toothing, double-action		8394220	•	•	83942207

* JL = jaw length when jaw section closed (approximate measurements)
 HF connection cable: see page THORAX107/108

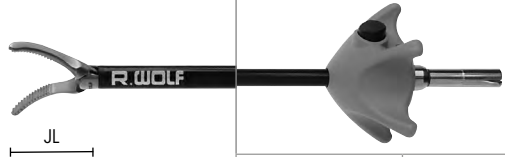
V125 | Subject to modifications. Please note that some products may not be available in all countries. Please always take note of the information that is provided with the product. For more detailed information, please consult with your contact partner or directly with Richard Wolf GmbH.

ERAGON modular

Ø 5.0 MM, INSULATED





Jaw insert			Sheath tube, Ø 5.0 mm, insulated		Handle, pistol-shaped		Complete instrument • Jaw insert with sheath tube • Handle
			SL 330 mm	SL 450 mm	with lock, without HF	with lock, with HF, mono	
	JL*	Product no.	8393933	8394933	83930072	83930074	Product no.
 Atraum. grasping forceps Ø 5 mm bndl atraumatic, with pyramid-shaped tothing and cross tothing, double-action	29 mm	8393223	•		•		83932237
		8394223		•	•		83942237
 Atraum. grasping forceps Ø 5 mm bndl atraumatic, single fenestrated with cross tothing, double-action	25 mm	8393250	•		•		83932507
		8394250		•	•		83942507
 Atraum. grasping forceps Ø 5 mm bndl atraumatic, double fenestrated and curved single-action	32 mm	8393229	•		•		83932297
		8394229		•	•		83942297
 Grasping forceps Ø 5 mm bndl atraumatic, narrow and rounded, double-action	15 mm	8393230	•		•		83932307
		8394230		•	•		83942307
 Dissector forceps mono Ø 5 mm bndl curved, double-action	19 mm	8393240	•			•	83932407
		8394240		•		•	83942407
 Dissector forceps mono Ø 5 mm bndl single fenestrated double-action	17 mm	8393242	•		•		83932427
		8394242		•	•		83942427



* JL = jaw length when jaw section closed (approximate measurements)

HF connection cable: see page THORAX107/108

V125 || Subject to modifications. Please note that some products may not be available in all countries. Please always take note of the information that is provided with the product. For more detailed information, please consult with your contact partner or directly with Richard Wolf GmbH.

ERAGON^{modular}
 Ø 5.0 MM, INSULATED

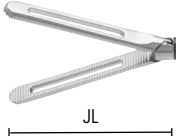







		Handle, axial			
ERAGON^{axial}					
All jaw inserts and sheath tubes can also be combined with ERAGON^{axial} .		with lock	without lock, with HF connector	without lock, with HF connector	with lock, not rotatable
Rotatable knob	Product no.	83930082	83930083	83930084	83930085
	8988	•	•	•	

Jaw insert		Sheath tube, Ø 5.0 mm, insulated		Handle, pistol-shaped		Complete instrument
						<ul style="list-style-type: none"> • Jaw insert with sheath tube • Handle
	JL*	SL 330 mm	SL 450 mm	with lock, without HF	with lock, with HF, mono	Product no.
Intestine grasping forceps Ø 5 mm bndl	38 mm	8393249		•		83932497
atraumatic, single fenestrated with cross toothing, double-action		8394249		•		83942497
Debaquey forceps mono Ø 5 mm bndl	35 mm	8393256		•	•	83932567
curved, double-action						
Debaquey forceps mono Ø 5 mm bndl	47 mm	8393258		•		83932587
double-action		8394258		•		83942587

* JL = jaw length when jaw section closed (approximate measurements)
 HF connection cable: see page THORAX107/108

ERAGON modular





Ø 5.0 MM, INSULATED







Jaw insert			Sheath tube, Ø 5.0 mm, insulated		Handle, pistol-shaped	Complete instrument • Jaw insert with sheath tube • Handle
			SL 330 mm	SL 450 mm	 without lock, with HF, mono	
			Product no.	8393933		8394933
 Metzenbaum scissors mono Ø 5 mm bndl 23 mm curved, double-action	JL*	8393.041	•		•	83930417
		8394.041		•	•	83940417
 Metzenbaum micro scissors mono Ø 5 mm bndl 18 mm curved, double-action	JL*	8393.044	•		•	83930447
 Scissors mono Ø 5 mm bndl 20 mm narrow, straight, double-action	JL*	8393.045	•		•	83930457
 Hook scissors mono Ø 5 mm bndl 14 mm serrated, single-action	JL*	8393.081	•		•	83930817
		8394.081		•	•	83940817
 Metzenbaum micro scissors mono Ø 5 mm bndl 21 mm double-action	JL*	8393243	•		•	83932437
		8394243		•	•	83942437
 Scissors mono Ø 5 mm bndl 26 mm curved and toothed double-action	JL*	8393246	•		•	83932467
		8394246		•	•	83942467

* JL = jaw length when jaw section closed (approximate measurements)

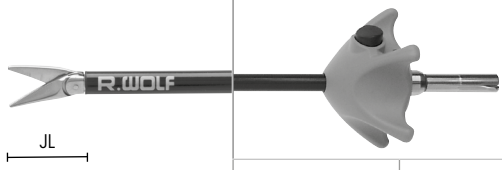
HF connection cable: see page THORAX107/108

ERAGON^{modular}
 Ø 5.0 MM, INSULATED

		Handle, axial			
ERAGON^{axial}					
All jaw inserts and sheath tubes can also be combined with ERAGON ^{axial} .		with lock	without lock, with HF connector	without lock, with HF connector	with lock, not rotatable
Rotatable knob	Product no.	83930082	83930083	83930084	83930085
	8988	•	•	•	

Jaw insert		Sheath tube, Ø 5.0 mm, insulated		Handle, pistol-shaped		Complete instrument
						<ul style="list-style-type: none"> • Jaw insert with sheath tube • Handle
	JL*	SL 330 mm	SL 450 mm	with lock, without HF	without lock, with HF, mono	
	Product no.	8393933	8394933	83930072	83930073	Product no.
Scissors mono Ø 5 mm bndl		•			•	83932487
	22 mm		•		•	83942487
fine-toothed, fine tip double-action		8394248				
Knot pusher Ø 5 mm bndl		•		•		83933457
	17 mm		•			83943457
with distal recess, double-action		8394345				
Gastric band manipulator Ø 5 mm bndl		•		•		83932537
	47 mm		•		•	83942537
90° articulating with distal slot		8394253				



* JL = jaw length when jaw section closed (approximate measurements)

HF connection cable: see page THORAX107/108

Accessories for manual and machine reprocessing	Product no.
	Irrigation adapter Ø 9 mm, length 64 mm 163502

V125 | Subject to modifications. Please note that some products may not be available in all countries. Please always take note of the information that is provided with the product. For more detailed information, please consult with your contact partner or directly with Richard Wolf GmbH.

ERAGON^{modu} blades
 Ø 5.0 MM, INSULATED

 All jaw inserts and sheath tubes can also be combined with ERAGONaxial.		Handle, axial 	
		without lock, with HF connector	
Rotatable knob	Product no.	83930083	
	8988	•	

Scissors attachment	Tension rod Ø 5.0 mm			Sheath tube insulated Ø 5.0 mm			Handle pistol-shaped	Complete instrument • Jaw insert with sheath tube • Handle	
									
	for SL 260 mm	for SL 330 mm	for SL 450 mm	SL 240 mm	SL 310 mm	SL 430 mm	without lock, rotatable with HF connector		
	Product no.	8392934	8393934	8394934	8392935	8393935	8394935	83930073	Product no.
Metzenbaum scissors attachment mono		•			•			•	83920407
	4393.040		•			•		•	83930407
(PU = 10 PCS), sterile, for single use				•			•	•	83940407







ERAGONMODULAR







3.5

V125 || Subject to modifications. Please note that some products may not be available in all countries. Please always take note of the information that is provided with the product. For more detailed information, please consult with your contact partner or directly with Richard Wolf GmbH.

HF connection cable: see page THORAX107/108

ERAGON^{modular}
 Ø 10 MM, UNINSULATED

		Handle, axial	
 All jaw inserts and sheath tubes can also be combined with ERAGONaxial.			
		with lock, without HF connector	with lock, without HF connector, not rotatable
Rotatable knob	Product no.	83930082	83930085
	8988	.	.

Jaw insert		Sheath tube, Ø 10.0 mm, uninsulated		Handle, pistol-shaped	Complete instrument	
					• Jaw insert with sheath tube • Handle	
		SL 327 mm	SL 447 mm	with lock, without HF		
	JL*	Product no.	8395902	8396902	83930072	Product no.
 Maryland dissector forceps Ø 10 mm bndl	36 mm	8395.225	.	.	.	83952257
		double-action	8396225	.	.	.
 Dissector forceps Ø 10 mm bndl	35 mm	8395.226	.	.	.	83952268
		angled, double-action	8396226	.	.	.
 Grasping forceps Ø 10 mm bndl	20 mm	8395.236	.	.	.	83952368
		Pike-mouth double-action	8396236	.	.	.
 Grasping forceps Ø 10 mm bndl	49 mm	8395.204	.	.	.	83952048
		2/3 clawed single-action	8396204	.	.	.

* JL = jaw length when jaw section closed (approximate measurements)
 HF connection cable: see page THORAX107/108







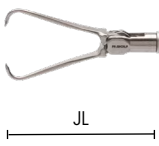

VI25 || Subject to modifications. Please note that some products may not be available in all countries. Please always take note of the information that is provided with the product. For more detailed information, please consult with your contact partner or directly with Richard Wolf GmbH.

ERAGONMODULAR

3.5

ERAGON modular

Ø 10 MM, UNINSULATED

Jaw insert			Sheath tube, Ø 10.0 mm, uninsulated			Handle, pistol-shaped		Complete instrument • Jaw insert with sheath tube • Handle
			SL 327 mm	SL 447 mm	SL 387 mm	with lock, without HF		
	JL*	Product no.	8395902	8396902	8397902	83930072	83930082	Product no.
 Claw grasping forceps Ø 10 mm bndl double-action	38 mm	8395.489	•			•		83954897
 Claw grasping forceps Ø 10 mm bndl with additional row of teeth, double-action	38 mm	8395490	•			•		83954907
 Babcock forceps Ø 10 mm bndl	42 mm	8395.187	•			•		83951877
large distal gripping surface with fine cross toothing, double-action		8396187		•		•		83961877
 Babcock forceps Ø 10 mm bndl double-action	38 mm	8395.214	•			•		83952148
 Plate-shaped grasping forceps Ø 10 mm bndl double-action	50 mm	8395.234	•			•		83952347
		8396234		•		•		83962347
 Spoon forceps Ø 10 mm bndl single-action	31 mm	8395.244	•			•		83952448
 Stapler head grasping forceps Ø 10 mm bndl angled 30°, double-action		8397.655			•		•	83976558



* JL = jaw length when jaw section closed (approximate measurements)/HF connection cable: see page THORAX107/108

ERAGON *stitch*
NEEDLE HOLDER Ø 3.5 MM

ERAGONMODULAR

3.5









Needle holder jaw insert			Sheath tube, Ø 3.5 mm		Needle holder handle		Complete instrument • Jaw insert • Sheath tube • Handle
	SL	240 mm	SL	330 mm	with on-off detent mechanism, single-action		
					Axial	Angled	
	JL*	Product no.	8390533	8391533	8393943	8393944	Product no.
	12 mm	8391505	•		•		83915053
			•		•		83915054
straight with carbide insert single-action		8391506		•	•		83915063
				•		•	83915064

* JL = jaw length when jaw section closed (approximate measurements)

Accessories for manual and machine reprocessing	Product no.
 Irrigation adapter cleaning Ø 9 mm, length 64 mm for uninsulated sheath tubes	163503

ERAGON^{stitch}

NEEDLE HOLDER Ø 5.0 MM

Needle holder jaw insert			Sheath tube, Ø 5.0 mm		Needle holder handle		Complete instrument • Jaw insert • Sheath tube • Handle
							
	JL*	Product no.	8393533	8394533	8393943	8393944	Product no.
	19 mm	8393507	•		•		83935073
			•			•	83935074
straight with carbide insert single-action	19 mm	8394507		•	•		83945073
				•		•	83945074
	19 mm	8393508	•		•		83935083
			•			•	83935084
straight and narrow with carbide insert single-action	19 mm	8394508		•	•		83945083
				•		•	83945084
	19 mm	8393509	•		•		83935093
			•			•	83935094
straight, with self-righting function single-action	19 mm	8394509		•	•		83945093
				•		•	83945094





* JL = jaw length when jaw section closed (approximate measurements)

Accessories for manual and machine reprocessing		Product no.
	Irrigation adapter cleaning Ø 9 mm, length 64 mm for uninsulated sheath tubes	163503

ERAGON *stitch*
NEEDLE HOLDER Ø 5.0 MM



ERAGONMODULAR



3.5

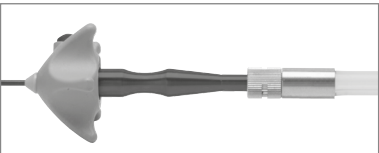

Needle holder jaw insert			Sheath tube, Ø 5.0 mm		Needle holder handle		Complete instrument • Jaw insert • Sheath tube • Handle	
								
								SL 330 mm
	JL*	Product no.	8393533	8394533	Axial	Angled	Product no.	
 Needle holder Ø 5 mm bndl	19 mm	8393518	•		•		83935183	
		8393518	•			•	83935184	
	curved right with carbide insert single-action	8394518			•	•		83945183
		8394518			•		•	83945184
 Needle holder Ø 5 mm bndl	19 mm	8393519	•		•		83935193	
		8393519	•			•	83935194	
	Curved left with carbide insert single-action	8394519			•	•		83945193
		8394519			•		•	83945194

Accessories for manual and machine reprocessing		Product no.
	Irrigation adapter cleaning Ø 9 mm, length 64 mm for uninsulated sheath tubes	163503

ERAGON*modular*
ACCESSORIES

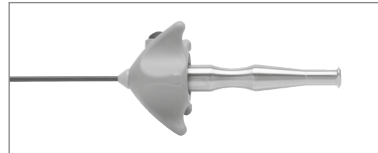
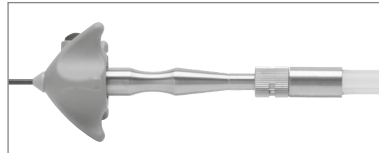









For insulated sheath tubes		Product no.
	For manual and machine reprocessing: Irrigation adapter Ø 9 mm, length 64 mm for insulated sheath tubes	163502
		



For uninsulated sheath tubes		Product no.
	For manual and machine reprocessing: Irrigation adapter cleaning Ø 9 mm, length 64 mm for uninsulated sheath tubes	163503
		

	8393932
	8394932

		Ø	SL	Product no.
	Sheath tube insulated Ø 5 mm SL 330 mm with distal cm scale	5 mm	330 mm	8393932
	Sheath tube insulated Ø 5 mm SL 450 mm with distal cm scale	5 mm	450 mm	8394932

HANDLE VARIANTS FOR MODULAR SYSTEMS



Handle, pistol-shaped 		rotatable	with lock	without lock	with HF	without HF	Product no.
		•	•			•	83930072
		•		•	•		83930073
		•	•		•		83930074
Handle, axial 		rotatable	with lock	without lock	with HF	without HF	Product no.
		•	•			•	83930082
		•		•	•		83930083
		•	•		•		83930084
			•			•	83930085
Optional for 83930082/83930083/83930084:							Product no.
		Rotatable knob autoclavable				8988	

All  components are compatible with 

VI25 | Subject to modifications. Please note that some products may not be available in all countries. Please always take note of the information that is provided with the product. For more detailed information, please consult with your contact partner or directly with Richard Wolf GmbH.

NEEDLE HOLDER HANDLE

Needle holder handle, axial	not rotatable	with lock	without HF	Product no.
	•	•	•	8393.941

Needle holder handle <small>ERAGON^{stitch}</small>	axial	angled	with on-off detent mechanism	single-action	not rotatable	Product no.
	•		•	•	•	8393943
		•	•	•	•	8393944

MULTIFUNCTIONAL SUCTION IRRIGATION SYSTEM

COMBINATION OPTIONS

MULTIFUNCTIONAL SUCTION AND IRRIGATION SYSTEM

3.6

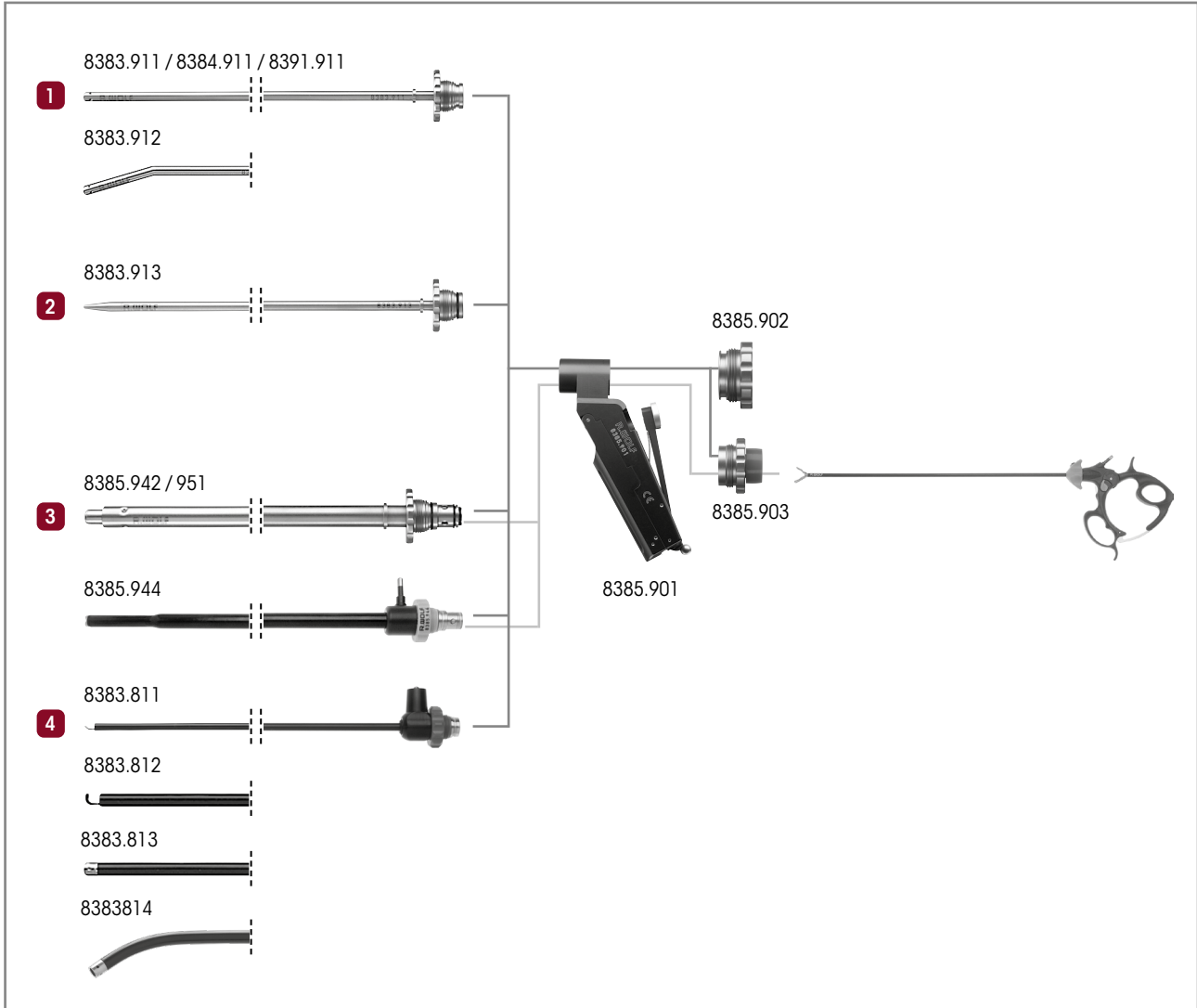

- 1 Suction or irrigation:**
- Suction irrigation tube Ø 5 mm WL 310 mm 8383.911
 - Suction irrigation tube Ø 5 mm WL 450 mm 8384.911
 - Suction irrigation tube Ø 3.5 mm WL 300 mm 8391.911
 - Suction irrigation tube curved Ø 5 mm WL 310 mm... 8383.912
 - for this: **Sealing cap** 8385.902

- 2 Blunt aquadissection:**
- Pressure irrigation tube Ø 5 mm WL 310 mm 8383.913
 - for this: **Sealing cap** 8385.902

- 3 Suction, irrigation, and use of auxiliary instruments Ø 5 mm:**
- Suction irrigation tube Ø 10 mm WL 225 mm 8385.942
 - Suction irrigation tube Ø 10 mm WL 330 mm 8385.951
 - Suction irrigation tube Ø mono 10 mm WL 330 mm, insulated, with atraumatic preparation tip 8385.944
 - for this: **Sealing adapter** 8385.903

- 4 Preparation of tissue with HF:**
- HF suction irrigation tube Ø 5.2 mm WL 317 mm insulated with integrated HF spatula probe** 8383.811
 - HF suction irrigation tube Ø 5.2 mm WL 317 mm insulated with integrated HF hook electrode** 8383.812
 - HF suction irrigation tube Ø 5.2 mm WL 317 mm insulated with integrated HF button electrode** 8383.813
 - HF suction irrigation tube Ø 5.4 mm WL 380 mm curved with distal openings, insulated with integrated HF button electrode** 8383.814
 - for this: **Sealing cap** 8385.902

V125 || Subject to modifications. Please note that some products may not be available in all countries. Please always take note of the information that is provided with the product. For more detailed information, please consult with your contact partner or directly with Richard Wolf GmbH.

MULTIFUNCTIONAL SUCTION IRRIGATION SYSTEM

SUCTION IRRIGATION HANDLE

 <p>8385.901</p> <p>AUTOGLAVE 134° C / 273° F</p> <p>8385.902</p> <p>8385.903</p>	
Product no.	
<p>Suction irrigation handle</p>	<p>8385.901</p>
<p>Sealing cap</p>	<p>8385.902</p>
<p>Required to use auxiliary instruments Ø 5 mm: Sealing attachment with opening and membrane valve</p>	<p>8385.903</p>
<p>Spare Sealing membrane Ø 17 mm yellow, Ø 17 mm, PU = 10 PCS, for instruments from 3 to 6 mm</p>	<p>89.103</p>

V125 || Subject to modifications. Please note that some products may not be available in all countries. Please always take note of the information that is provided with the product. For more detailed information, please consult with your contact partner or directly with Richard Wolf GmbH.

MULTIFUNCTIONAL SUCTION IRRIGATION SYSTEM

SUCTION IRRIGATION TUBE SETS – ILLUSTRATION

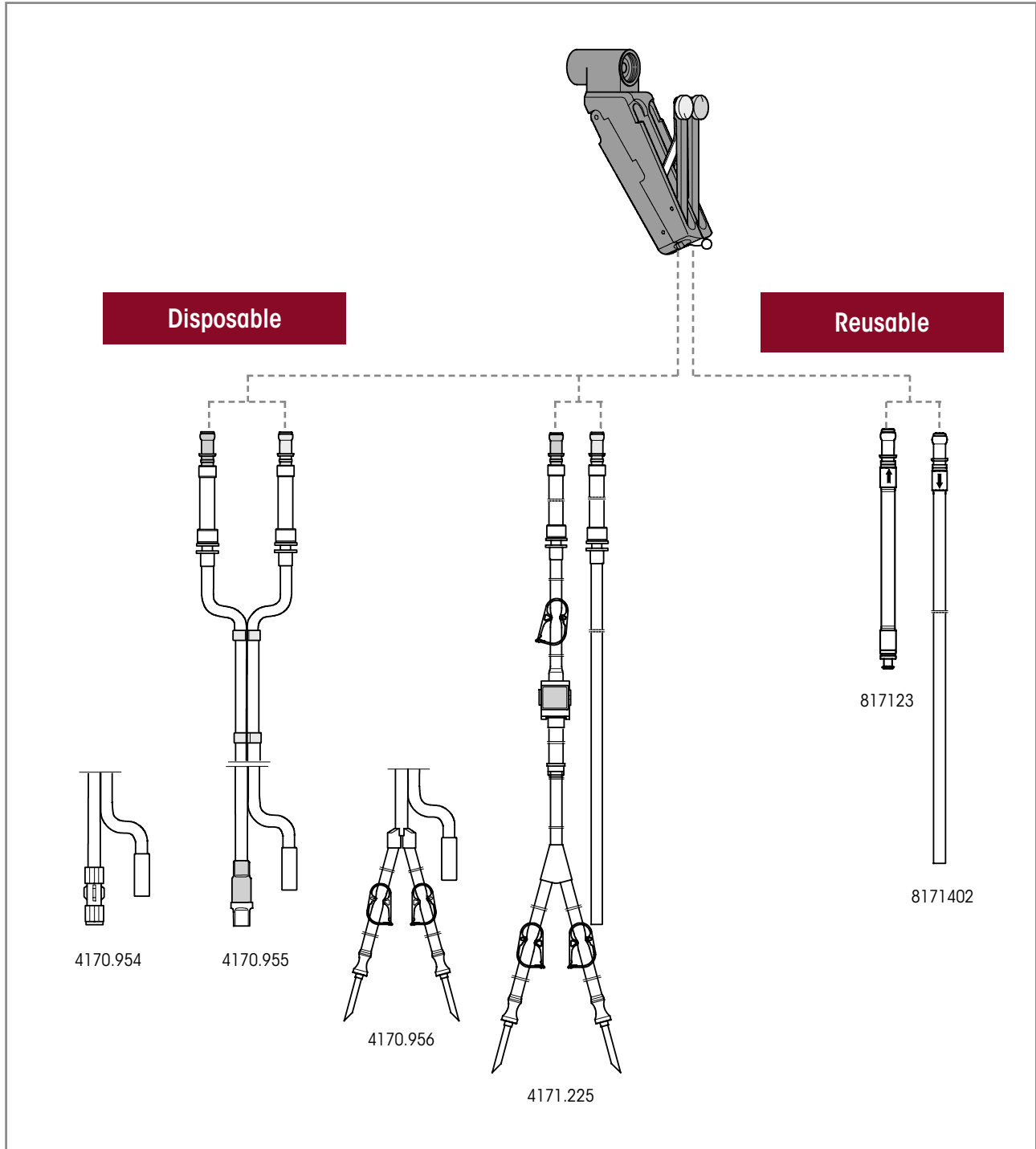

Suction irrigation tube sets are used in conjunction with the suction irrigation handle 8385.901 and pump-side tube systems as well as corresponding collection and secretion containers and/or vacuum pumps.

MULTIFUNCTIONAL SUCTION IRRIGATION SYSTEM



SUCTION IRRIGATION TUBE SETS FOR SUCTION IRRIGATION HANDLE 8385.901

Disposable		Product no.
Suction irrigation tube set, L 3 m (PACK= 10 PCS), sterile	Irrigation tube: With Luer-Lock, for connection to the irrigation tube of a suction irrigation tube set, e.g., irrigation tube of the Endo-Irrigator 2211 Suction tube: For connection to a collection or secretion container and/or vacuum pump	4170.954
Suction irrigation tube set with care-lock, L 3 m (PACK= 10 PCS), sterile	Irrigation tube: With CARE-LOCK, for connection to an irrigation container Suction tube: For connection to a collection or secretion container and/or vacuum pump	4170.955
Suction irrigation tube set with piercing spike, L 3 m (PACK= 10 PCS), sterile	Irrigation tube: With 2 piercing spikes, for connection to an irrigation container Suction tube: For connection to a collection or secretion container and/or vacuum pump	4170.956
Suction irrigation tube set, L 3 m (PACK= 10 PCS), sterile	Irrigation tube: With 2 piercing spikes, for connection to an irrigation container, and Fluid Control Lap 2216 Suction tube: For connection to a collection or secretion container and/or vacuum pump Also observe instruction manual GA-A 276	4171.225
Secretion container, 2.5 l	2.5 liters	41706566
Tube set for suction (2 connections)	sterile disposable product (PACK= 10 PCS), for connecting instruments to collecting container	T0503-01



Reusable		Product no.
Irrigation tube L 1.2 m	Irrigation tube: With Luer-Lockconnection for connection to the irrigation tube of a suction irrigation tube set, e.g., 8171223 or 8170.223	817123
Suction tube L 3 m	silicone, for suction irrigation handle 8385.901	8171402
Secretion container, 2 l	2 liters, without cover	8170.6551
Cover	for secretion trap 8170.6551, reusable	8170.6552

MULTIFUNCTIONAL SUCTION IRRIGATION SYSTEM

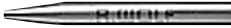
SUCTION IRRIGATION TUBES

		Outer Ø	WL	Product no.
				
	Suction irrigation tube Ø 3.5 mm WL 300 mm	3,5 mm	300 mm	8391.911
	Suction irrigation tube Ø 5 mm WL 310 mm	5,0 mm	310 mm	8383.911
	Suction irrigation tube Ø 5 mm WL 450 mm	5,0 mm	450 mm	8384.911
	Suction irrigation tube curved Ø 5 mm WL 310 mm	5,0 mm	310 mm	8383.912
	Pressure irrigation tube Ø 5 mm WL 310 mm	5,0 mm	310 mm	8383.913

For use of 5 mm auxiliary instruments

		Outer Ø	WL	Product no.
				
	Suction irrigation tube Ø 10 mm WL 225 mm	10,0 mm	225 mm	8385.942
	Suction irrigation tube Ø 10 mm WL 330 mm	10,0 mm	330 mm	8385.951
Capacity 5.0 mm				

MULTIFUNCTIONAL SUCTION IRRIGATION SYSTEM

SUCTION IRRIGATION TUBES







		Outer Ø	WL	Product no.
	Suction irrigation tube mono Ø 10 mm WL 330 mm	10,0 mm	330 mm	8385.944
Insulated, with atraumatic preparation tip				

required for 8385.951:			Product no.
	Sealing attachment	with opening and membrane valve sealing membrane Ø 17 mm	8385.903

MULTIFUNCTIONAL SUCTION IRRIGATION SYSTEM

SUCTION IRRIGATION TUBES

		Outer Ø	WL	Product no.
	Insulated with integrated HF spatula probe	5.2 mm	317 mm	8383.811
	Insulated with integrated HF hook probe	5.2 mm	317 mm	8383.812
	Insulated with integrated HF button electrode	5.2 mm	317 mm	8383.813
As alternative to suction irrigation handle:				
	Suction irrigation adapter with maintenance-free two-way stopcock, for multi-functional suction and irrigation tube system			8583819

Accessories	Product no.
HF connection cable	See THORAX107/108

ACCESSORIES FOR SUCTION AND IRRIGATION

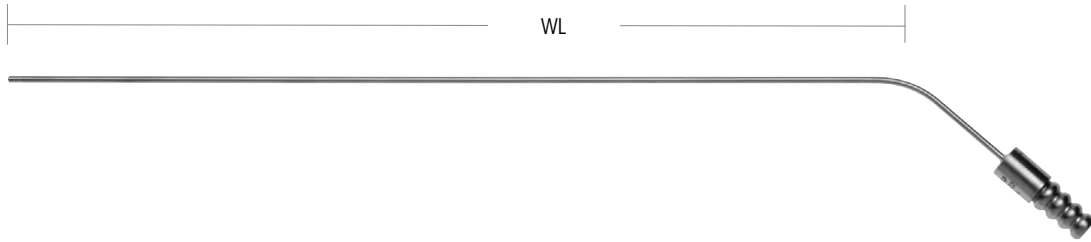

		Outer Ø	WL	Product no.
 central, lateral openings, rigid	Suction tube OD 2 mm WL 250 mm	2.0 mm	250 mm	8291.22
	Suction tube OD 2.5 mm WL 250 mm	2.5 mm	250 mm	8291.23
	Suction tube OD 3 mm WL 250 mm	3.0 mm	250 mm	8291.24
	Suction tube OD 4 mm WL 500 mm	4.0 mm	500 mm	8291.45



		Outer Ø	WL	Product no.
 graduated, with 3 mm Luer connecto	Suction tube OD 2.8 mm WL 450 mm	2.8 mm	450 mm	8380.68
	Suction tube graduated Ø 5 mm WL 330 mm	5.0 mm	330 mm	8383.68
	Suction tube OD 4.7 mm WL 450 mm	4,7 mm	450 mm	8384.68

ACCESSORIES
FOR SUCTION AND IRRIGATION

ACCESSORIES FOR SUCTION AND IRRIGATION

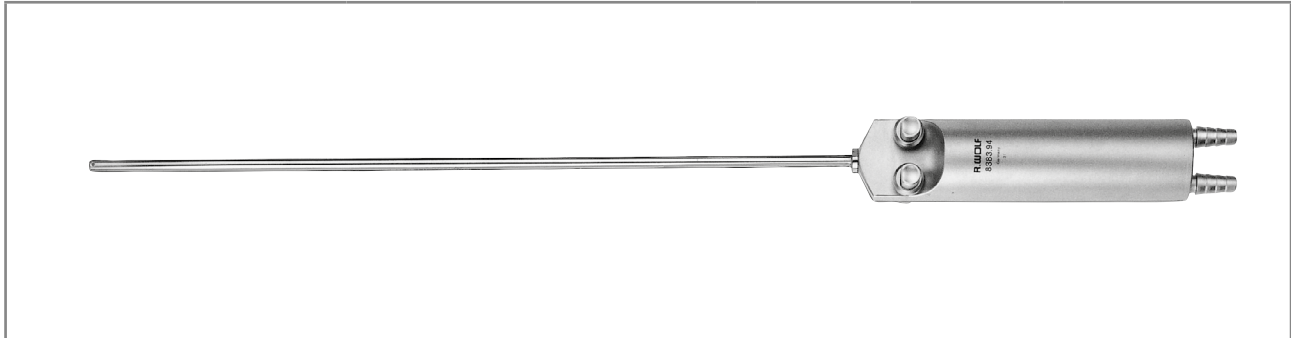

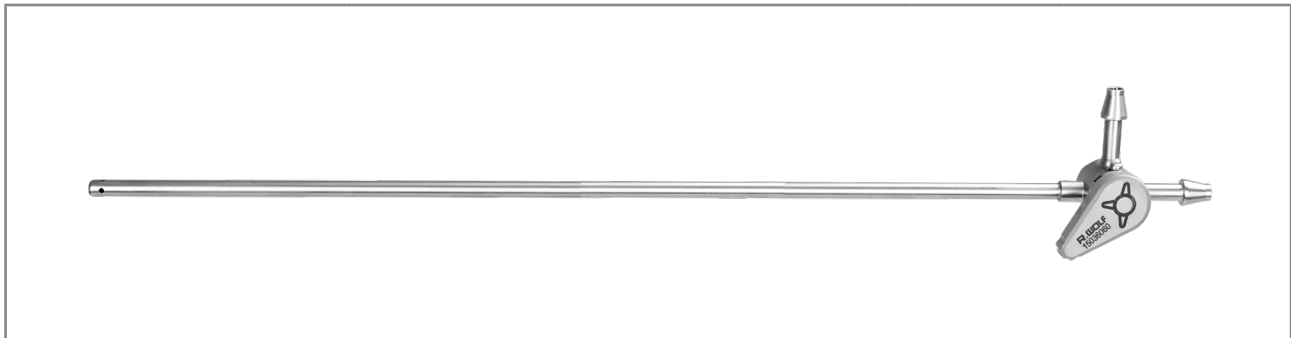

		Outer Ø	WL	Product no.
	Suction irrigation tube Ø 5 mm WL 300 mm	5,0 mm	300 mm	8383.94
with stop valve				



		Outer Ø	WL	Product no.
	Suction irrigation tube WL 290 mm	5.0 mm	290 mm	8583732
with maintenance-free two-way stopcock, sheath tube, with distal openings, reusable	Suction irrigation tube WL 410 mm	5.0 mm	410 mm	8584732

VI25 || Subject to modifications. Please note that some products may not be available in all countries. Please always take note of the information that is provided with the product. For more detailed information, please consult with your contact partner or directly with Richard Wolf GmbH.

HAND BLOWER FOR SINGLE USE FOR SUCTION AND IRRIGATION

				
for air insufflation		Outer Ø	TL	Product no.
	<p>Hand blower with disposable filter, sterile (PU = 5 PCS)</p>	49 mm	567 mm	412700

ELECTRODES 5.0 MM
MONOPOLAR





		Outer Ø	WL	Product no.
	Coagulation electrode mono Ø 5 mm WL 330 mm	5.0 mm	330 mm	8383.40
	Coagulation electrode mono Ø 5 mm WL 450 mm	5.0 mm	450 mm	8384.40



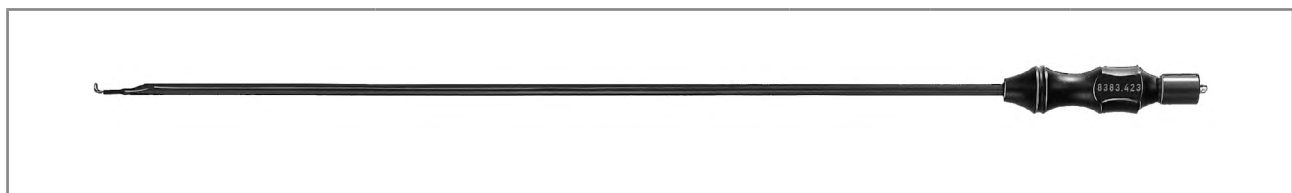

		Outer Ø	WL	Product no.
	Hook electrode mono Ø 5 mm WL 340 mm	5.0 mm	340 mm	8242.301





		Outer Ø	WL	Product no.
	Hook electrode mono Ø 5 mm WL 340 mm	5.0 mm	340 mm	8383.423
	Hook electrode mono Ø 5 mm WL 420 mm		420 mm	8384.423
	Needle electrode mono Ø 5 mm WL 340 mm	5.0 mm	340 mm	8383.426
	Spatula electrode mono Ø 5 mm WL 340 mm	5.0 mm	340 mm	8383.428



HF connection cable: see page THORAX107/108

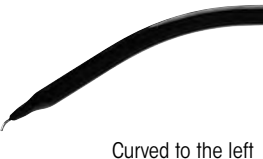

ELECTRODES 3.0 MM/4.9 MM

		Outer Ø	WL	Product no.
	Hook electrode mono Ø 3 mm WL 470 mm	3.0 mm	470 mm	84420.0003

		Outer Ø	WL	Product no.
	Hook electrode mono Ø 4.9 mm WL 330 mm Curved to the left	4.9 mm	330 mm	84420.0004
	Hook electrode mono Ø 4.9 mm WL 330 mm Curved to the right	4.9 mm	330 mm	84420.0006
	Hook electrode mono Ø 7 mm WL 335 mm Curved		335 mm	84420.0005







NEEDLE HOLDER / KNOT PUSHER 5 MM





		Outer Ø	WL	Product no.
 <p>Curved</p>	Needle holder Ø 5.0 mm WL 300 mm	5.0 mm	300 mm	8242.451

		Outer Ø	WL	Product no.
	Hook probe TL 350 mm, SZ 5 mm	5.0 mm	350 mm	8243.461

ERAGON modular

MODULAR KNOT PUSHER Ø 5.0 MM, INSULATED

		Handle, axial			
					
All jaw inserts and sheath tubes can also be combined with ERAGONaxial .		with lock	without lock, with HF connector	without lock, with HF connector	with lock, not rotatable
Rotatable knob	Product no.	83930082	83930083	83930084	83930085
	8988	•	•	•	•



Jaw insert				Handle	Complete instrument • Jaw insert with sheath tube • Handle	
  JL		SL 330 mm	SL 450 mm	 with lock, without HF		
	JL*	Product no.	8393933	8394933	83930072	Product no.
Knot pusher Ø 5 mm bndl	17 mm	8393.345	•	•	•	83933457
 with distal recess, double-action		8394345	•	•	•	83943457

* JL = jaw length when jaw section closed (approximate measurements)

HF connection cable: see page Thorax107

V125 || Subject to modifications. Please note that some products may not be available in all countries. Please always take note of the information that is provided with the product. For more detailed information, please consult with your contact partner or directly with Richard Wolf GmbH.

CANNULA / SPONGE FORCEPS 3 MM

				
with Luer connector		Outer Ø	WL	Product no.
 Tip Ø 1.4 mm	Injection cannula Ø 3 mm WL 340 mm	3.0 mm	340 mm	8379.732

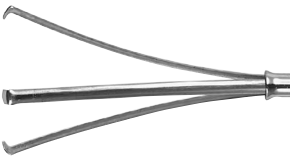
				
		Outer Ø	WL	Product no.
	Sponge forceps Ø 3.0 mm WL 300 mm	3.0 mm	300 mm	8148.02

bee-system II

Sternum saw



		Product no.
bee-system II Sternum saw	with keyless top for sternum (F-30-400-05)	F-31-601-00
Accessories: see page Thorax106		

- Precise incision with excellent visibility
- Easy clamping of the saw blade (no tools required)
- Use of saw blades with Stryker adapter
- Protection sleeve can be fastened in 4 different positions (locked in each position at 90°)
- Basic model can be used as jigsaw.

Technical data for F-31-601-00	
Handpiece dimensions (without top)	185 x 111 x 206 mm
Handpiece weight (with power pack)	1,750 g
Continuously adjustable speed	0–7,500 cycles/min (level I) / 0–10,000 cycles/min (level II)
Protection class	B, EN 60601-1
Power supply	Internal battery

bee-system II

Power pack

Universal drive unit for all bee-system handpieces



		Product no.
Power pack	Universal drive unit for all bee-system handpieces, latest Li-ion technology.	F-30-900-00
for this: Charging unit: see page Thorax105		

- 1 Power pack for all handpieces
- Contains control device, battery, electronic components, and motor all in one power pack
- Automatic detection of the power parameters depending on the handpiece used
- Unique shelf life, no need to sterilize sensitive components
- Latest battery technology – long service life, no memory effect
- Battery charge control indicator: green, orange, red (discharged)
- White LEDs for additional illumination of the surgical area

Technical data for F-30-900-00	
Dimensions	89 x 87 x 102 mm
Weight	760 g
Model	Li-ion
Max. voltage	16.8 V
Operating voltage (nominal voltage)	14.4 V
Capacity	2.1 Ah
Average charge time	< 90 min

bee-system II

Charging unit



	Product no.
Charging unit (1 charging slot)	F-30-900-50
Charging unit (2 charging slots)	F-30-900-51
Charging unit (4 charging slots)	F-30-900-52







- All charging units display the charge state of the power packs.
- In addition to the charge state, the charging unit displays the charge capacity for each power pack slot.

Technical data for F-30-900-50/51/52	
Dimensions	1 charging slot: 157 x 140 x 79 mm 2 charging slots: 240 x 190 x 130 mm 4 charging slots: 520 x 190 x 130 mm
Weight	1 charging slot: 1,740 g 2 charging slots: 4,939 g 4 charging slots: 8,700 g
Model	Li-ion battery charging unit
Input	100–240 V AC 50–60 Hz 0.9 A
Output	16.8 V DC 2.0 A

bee-system II







Accessories



Accessories for bee-system II		Product no.
	Perforated basket with lid, for 1 machine without rinsing set, reusable	F-31-910-13
	Perforated basket with lid, for 2 machines without rinsing set, reusable	F-31-910-18
	Rinsing set reusable	F-30-910-40
	Cleaning brush set reusable	F-30-910-50
	Hi Tech Oil Pen	F-30-900-61
	Sterile insert For using the F-30-900-00 power pack under sterile conditions, reusable	F-30-900-20
	Lubrication stand reusable	F-30-900-10
	POAG cable for charging units for connecting F-30-900-50 or F-30-900-51 or F-30-900-52 to the potential equalization	F-30-900-57

VI25 || Subject to modifications. Please note that some products may not be available in all countries. Please always take note of the information that is provided with the product. For more detailed information, please consult with your contact partner or directly with Richard Wolf GmbH.

HF CONNECTION CABLE MONO 815xxx









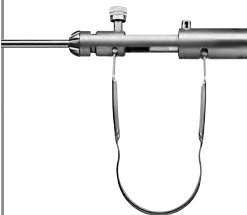

Instrument connector	Device connector		Product no.
<p>WOLF Resectoscopes</p> 		<p>HF connection cable mono L 3 m</p>	<p>815.032</p>
	<p>ERBE (ACC/ICC/IO)/BOWA (EU) R. Wolf HF surgical generator 400 kHz 2260002</p>	<p>HF connection cable mono L 5 m</p>	<p>815.052</p>
		<p>HF connection cable mono L 3 m</p>	<p>815.132</p>
	<p>ERBE (T series)</p>	<p>HF connection cable mono L 5 m</p>	<p>815.152</p>
<p>HF electrodes, monopolar</p> 		<p>HF connection cable mono L 3 m</p>	<p>815.031</p>
	<p>Martin (M-version)/Berchtold/ Aesculap</p>	<p>HF connection cable mono L 5 m</p>	<p>815.051</p>
		<p>HF connection cable mono L 3 m</p>	<p>815.033</p>
	<p>Bovie/Valleylab/Erbe (Int.)/ BOWA (Int.) R. Wolf HF surgical generator 400 kHz 2260001</p>	<p>HF connection cable mono L 5 m</p>	<p>815.053</p>
		<p>HF connection cable mono L 3 m</p>	<p>815.034</p>
	<p>BOWA (Int./EU) Eschmann and other devices with 4 mm plugs R. Wolf HF surgical generator 400 kHz 2260001</p>	<p>HF connection cable mono L 5 m</p>	<p>815.054</p>

HF CONNECTION CABLE MONO 8106xxx





Instrument connector	Device connector		Product no.
WOLF Instruments/surgical generator 		HF connection cable mono L 3 m	8106.032
	ERBE (ACC/ICC/IO)/BOWA (EU) R. Wolf HF surgical generator 400 kHz 2260002	HF connection cable mono L 5 m	8106.052
		HF connection cable mono L 3 m	8106.132
	ERBE (T series)	HF connection cable mono L 5 m	8106.152
HF electrodes, monopolar 		HF connection cable mono L 3 m	8106.031
	Martin (M-version)/Berchtold/ Aesculap	HF connection cable mono L 5 m	8106.051
		HF connection cable mono L 3 m	8106.033
	Bovie/Valleylab/Erbe (Int.)/ BOWA (Int.) R. Wolf HF surgical generator 400 kHz 2260001	HF connection cable mono L 5 m	8106.053
		HF connection cable mono L 3 m	8106.034
BOWA (Int./EU) Eschmann and other devices with 4 mm plugs R. Wolf HF surgical generator 400 kHz 2260001/2260002	HF connection cable mono L 5 m	8106.054	

BIPO HF CONNECTION CABLE

8108xxx

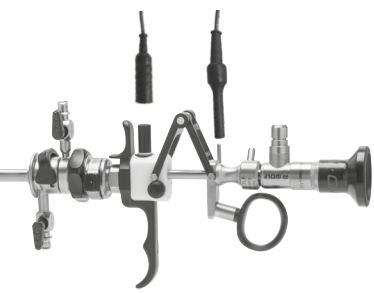

Instrument connector	Device connector		Product no.
WOLF Bipolar forceps 	 ERBE (ACC/ICC/T)/BOWA (EU) R. Wolf HF surgical generator 400 kHz 2260001/2260002	HF connection cable bipo; L 3 m	8108.032
		HF connection cable bipo; L 5 m	8108.052
	 International / 2-pin Valleylab R. Wolf HF surgical generator 400 kHz 2260001/2260002	HF connection cable bipo; L 3 m	8108.033
		HF connection cable bipo; L 5 m	8108.053
	 WOLF/Martin (M-version)/ Berchtold/Aesculap	HF connection cable bipo; L 3 m	8108.031
		HF connection cable bipo; L 5 m	8108.051
	 EMC Dolley	HF connection cable bipo; L 3 m	8108035
	Bipolar tweezers connection 	 ERBE (ACC/ICC/T)/BOWA (EU) R. Wolf HF surgical generator 400 kHz 2260001/2260002	HF connection cable bipo; L 3 m
HF connection cable bipo; L 5 m			8108.152
 International / 2-pin Valleylab R. Wolf HF surgical generator 400 kHz 2260001/2260002		HF connection cable bipo; L 3 m	8108.133
		HF connection cable bipo; L 5 m	8108.153
 Martin (M-version)/Berchtold/ Aesculap		HF connection cable bipo; L 3 m	8108.131
		HF connection cable bipo; L 5 m	8108.151
 EMC Dolley		HF connection cable bipo; L 3 m	8108135

HF CONNECTION CABLE BIPO FOR RESECTION IN SALINE SOLUTION

Instrument connector	Device connector		Product no.
<p>WOLF S(a)line resectoscopes</p> 	 Erbe VIO 300D	<p>Bipolar cable; TUR/TCR; WOLF</p> <p>MF plug; L 4 m</p>	<p>20196-119</p>
	 Erbe VIO 3	<p>Bipolar cable; MF-U</p> <p>MF plug; L 4.5 m</p>	<p>21196-119</p>
	 KLS Martin	<p>HF connection cable bipo; L 3 m</p>	<p>8108.231</p>
		<p>HF connection cable bipo; L 5 m</p>	<p>8108.251</p>
	 R. Wolf HF surgical generator 400 kHz 2260001/2260002	<p>HF connection cable bipo; L 3 m</p>	<p>8108233</p>
		<p>HF connection cable bipo; L 5 m</p>	<p>8108253</p>

VI25 || Subject to modifications. Please note that some products may not be available in all countries. Please always take note of the information that is provided with the product. For more detailed information, please consult with your contact partner or directly with Richard Wolf GmbH.

MONO HF NEUTRAL ELECTRODE CABLE

Instrument connector	Device connector		Product no.
<p>2-pole neutral electrode</p> 	 <p>R. Wolf HF surgical generator 400 kHz 2260001/2260002</p>	<p>Mono HF neutral electrode cable, L 4.5 m</p>	<p>2260031</p>

Subject to modifications.

THORAX en221025

