

**BRONCHOSCOPY /  
THORACOSCOPY /  
MEDIASTINOSCOPY**

**FLEXIBLE 1-CHANNEL SENSOR BRONCHOSCOPE**  
**"SLIM"**  
 FOR **ENDOCAM Logic 4K** CONTROLLER



DIAGNOSTIC MODEL	Outer Ø	Working channel	WL	TL	Direction of view	Angle of view	Product no.
Sensor bronchoscope Ø 3.3 mm WL 680 mm with suction valve	3.3 mm	1.5 mm	680 mm	980 mm	6.5°	90°	7235011

Recommended accessories		Product no.
Perforated basket for flexible endoscopes for this: fixing ring Ø 50.39 mm		(W x H x D): 448 x 106 x 288 mm <b>33016</b>
		<b>643301261</b>
Flexible auxiliary instruments		see Thorax5

# FLEXIBLE 1-CHANNEL SENSOR BRONCHOSCOPE

## "SLIM"











### TECHNICAL DATA

Sensor bronchoscope	7235011
Sheath Ø	3.3 mm
Working / irrigation channel Ø	1.5 mm
Angle	150° upward, 150° downward
Working length	680 mm
Angle of view	90°
Illumination	Two LEDs in handle, no separate light source required
Handle	Ergonomic handle design with axial cable outlet
Positioning of the working and irrigation channels in relation to the picture	At 9 o'clock
Endopicture	Square, digital 6x zoom Automatic white balance, light control, and focus
Cable length	2.5 m
Compatible endocamera	ENDOCAM Logic 4K ENDOCAM Logic HD ENDOCAM Logic HD lite

ENDOCAM LOGIC 4K – video equipment	Product no.
 <p><b>ENDOCAM Logic 4K camera control unit bndl</b> consisting of: ENDOCAM Logic 4K camera control unit (5525301) Handheld remote control (5525401) 1x USB flash memory 32 GB (72321829) 1x HDMI/HDMI cable, lockable, 3.0 m (103847) 1x power cable (2440.03)</p>	<b>55253011</b>

VI25 || Subject to modifications. Please note that some products may not be available in all countries. Please always take note of the information that is provided with the product. For more detailed information, please consult with your contact partner or directly with Richard Wolf GmbH.

# FLEXIBLE 1-CHANNEL SENSOR BRONCHOSCOPE "SLIM" ACCESSORIES AND AUXILIARY INSTRUMENTS

Recommended accessories		Outer Ø	Product no.
	<b>Flex. grasping forceps 3 FR WL 920 mm</b>	1.0 mm	<b>828.651</b>
	<b>Flex. biopsy forceps 3 FR WL 920 mm</b>	1.0 mm	<b>829.601</b>
	<b>Biopsy valve receptacle</b> (for sealing valve 15114.052)		<b>15114175</b>
	<b>Sealing valve, bundle (20 pcs)</b>		<b>15114.052</b>
	<b>Clamping attachment</b>		<b>8290020</b>
	<b>Seal</b>		<b>15176173</b>
	<b>Suction valve for bronch.</b> sterile (PU = 20 pcs)		<b>4565901M</b>
	<b>Irrigation adapter</b> for machine cleaning or manual flushing of flexible bronchoscopes with suction valve		<b>163912</b>
	<b>Tube with LUER-LOCK connector</b>		<b>886.00</b>
	<b>Luer sealing cap</b> for sealing the 2nd Luer connector or for sealing the probe channel if the bronchoscope should only be used for suction		<b>15023205</b>
	<b>Adapter</b> for automatic leak test		<b>163.905</b>
	<b>Leak tester for flexible endoscopes</b>		<b>163.903</b>
	<b>Pressure equalization valve</b> for low-temperature sterilization procedure with n hydrogen peroxide H2O2 and n Low Temperature Steam Formaldehyde (LTSF)		<b>163.904</b>
 for single use	<b>Cleaning brush Ø 2 mm TL 1200 mm</b> for flexible endoscopes with channel Ø 1.0-1.5 mm, Brush length 15 mm, PACK = 10 pcs, color: yellow		<b>7990001</b>
 for single use	<b>Double conical straight cleaning brush</b> for connections to the suction and working channel, PACK=50 pcs, color: red		<b>7980002</b>
 for single use	<b>Cleaning brush</b> straight, PACK = 10 PCS		<b>8691</b>
	<b>Laser fiber Ø 200 µm, disposable, sterile (PU = 1 pcs)</b>	200 µm	<b>487501200</b>
	<b>Laser fiber Ø 272 µm, disposable, sterile (PU = 1 pcs)</b>	272 µm	<b>487501272</b>
	<b>Laser fiber Ø 200 µm, reusable, sterile (PU = 1 pcs)</b>	200 µm	<b>87501200</b>
	<b>Laser fiber Ø 272 µm, reusable, sterile (PU = 1 pcs)</b>	272 µm	<b>87501272</b>
	<b>Laser fiber Ø 365 µm, reusable, sterile (PU = 1 pcs)</b>	365 µm	<b>875013650</b>

# OPTICAL BRONCHOSCOPE TEXAS MODEL

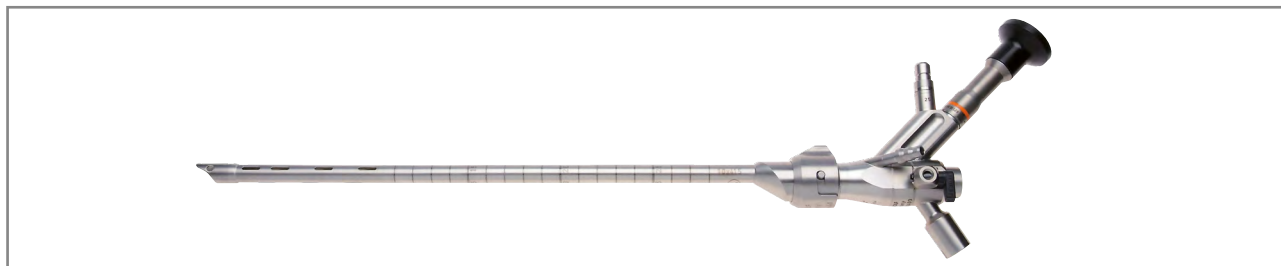

- The endoscope is integrated directly into the bronchoscope tube and offers an optimal view at all times.

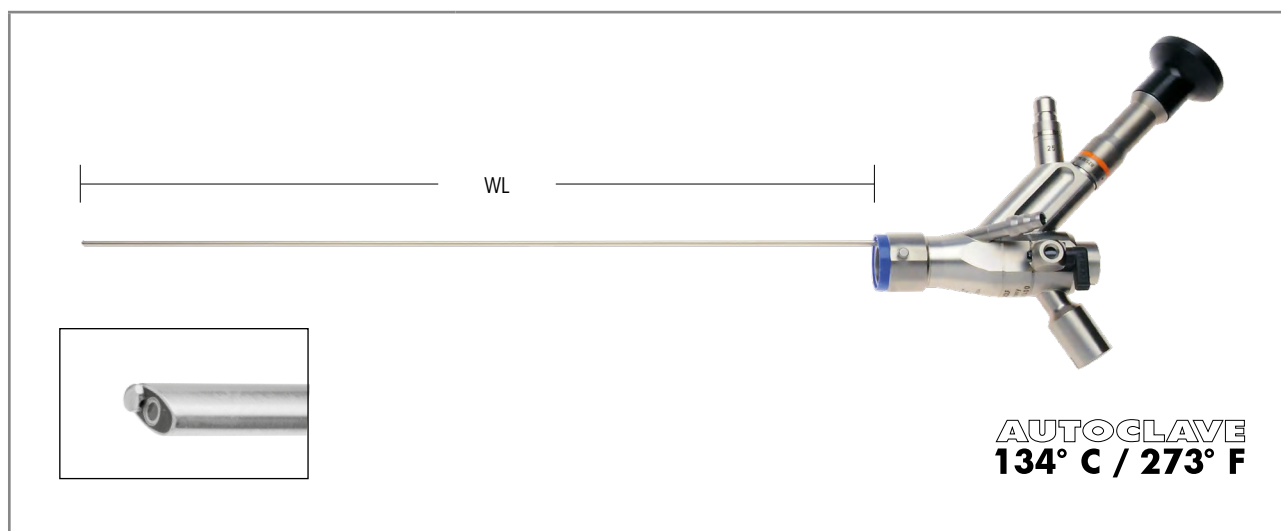











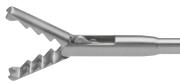
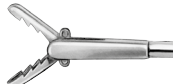

		Product no.
<b>Optic element bundle</b>	consisting of: Telescope 17° W 4.4 mm H 2 mm WL 314 mm (82510.1400) Respiration adapter for jet ventilation (8238.502) Connection part for bronch. nozzle (15401.071) Rubber cap without holes (88.00) Spare O-ring for 15401.071 (PU = 5 PCS) (9500.071) Spare seal, 5 PCS (15176141)	<b>825101401</b>

Optional accessories		
<b>Fiber light cable bndl</b> consisting of: Fiber light cable Ø 2.5 mm TL 2.3 m (80662523), projector-side adapter (8095.07), and endoscope-side adapter (809509)	Ø 2.5 mm, 2.3 m long	<b>806625231</b>
<b>Accessories and auxiliary instruments</b>		see THORAX7
<b>Bronchoscope / tracheoscope tubes Texas model</b>		see THORAX10

# OPTICAL BRONCHOSCOPE



## TEXAS MODEL

### ACCESSORIES AND AUXILIARY INSTRUMENTS

Recommended accessories			Product no.
	<b>Grasping forceps WL 465 mm, serrated</b>	for bronchoscope tubes with inner $\varnothing \geq 6$ mm	<b>8280.41</b>
	<b>Universal forceps WL 465 mm, serrated</b>		<b>8280.42</b>
	<b>Biopsy forceps WL 460 mm, smooth</b>		<b>8280.43</b>
	<b>Grasping forceps WL 465 mm</b>		<b>8280.47</b>
	<b>Sealing cap for bronch.</b> with telescope sealing cap for telescopes $\varnothing 5.5$ mm		<b>8020.18</b>
	<b>Sealing cap for bronch.</b> with telescope sealing cap for telescopes $\varnothing 4$ mm, 3.4 mm, and 2.7 mm		<b>8021.18</b>
	<b>Universal cap for bronch.</b>		<b>8020.15</b>
	<b>Spare telescope sealing caps (PACK=10 PCS)</b>		
	for telescopes $\varnothing 5,5$ mm	<b>Sealing cap CAP 5,1-6,0 mm</b>	<b>89.03</b>
	for telescopes $\varnothing 4$ mm	<b>Sealing cap CAP 3,4-5,1 mm</b>	<b>89.02</b>
	for telescopes $\varnothing 2,7$ mm und 3,4 mm	<b>Sealing cap CAP 2,4-3,4 mm</b>	<b>89.01</b>
 8238.502	<b>Respiration adapter jet ventilation bndl</b> consisting of: Respiration adapter for jet ventilation (8238.502) and Luer connector (15401.071)		<b>8238.5021</b>
 15401.071			
			<b>82510.0011</b>
For optic element bundle (825101401): <b>Protection sleeve, bndl</b> for transportation, reprocessing, and sterilization			<b>15208.289</b>
	<b>Container</b> (W x H x D): 500 x 60 x 200 mm		<b>33024</b>
	<b>Perforated basket for small parts</b> (W x H x D): 128 x 35 x 121 mm		<b>33006</b>

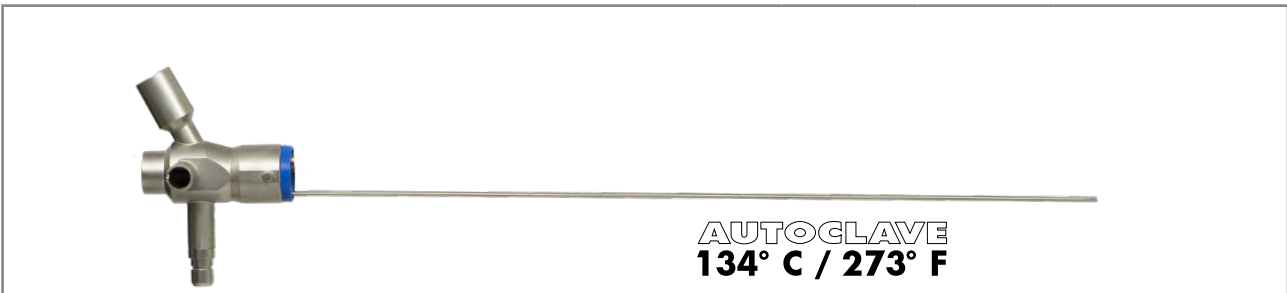











**BRONCHOSCOPE  
TEXAS MODEL**



		Inner Ø	TL	Product no.
	Head system for TEXAS bronchoscope with distal illumination	14.0 mm	372 mm	<b>825101100</b>
	Head system for TEXAS bronchoscope with proximal illumination	14.0 mm	373 mm	<b>825101200</b>

Optional accessories	
Accessories and auxiliary instruments	see THORAX9

# BRONCHOSCOPE TEXAS MODEL ACCESSORIES AND AUXILIARY INSTRUMENTS

Recommended accessories		Product no	
	<b>Sealing cap with monitoring window</b>	<b>8205.12</b>	
	<b>Sealing cap (blue)</b>	<b>8205.13</b>	
	<b>Sealing cap for bronch.</b> with telescope sealing cap for telescopes Ø 5.5 mm	<b>8020.18</b>	
	<b>Sealing cap for bronch.</b> with telescope sealing cap for telescopes Ø 4 mm, 3.4 mm, and 2.7 mm	<b>8021.18</b>	
	<b>Uni.-Verschlusskappe für Bronch.</b>	<b>8020.15</b>	
	<b>Spare telescope sealing caps (PACK=10 PCS)</b>		
	for telescopes Ø 5,5 mm	<b>Sealing cap CAP 5,1-6,0 mm</b>	<b>89.03</b>
	for telescopes Ø 4 mm	<b>Sealing cap CAP 3,4-5,1 mm</b>	<b>89.02</b>
	for telescopes Ø 2,7 mm und 3,4 mm	<b>Sealing cap CAP 2,4-3,4 mm</b>	<b>89.01</b>
 8238.502	<b>Respiration adapter jet ventilation bndl</b> consisting of: Respiration adapter for jet ventilation (8238.502) and Luer connector (15401.071)	<b>8238.5021</b>	
 15401.071			
	<b>Illumination insert</b>	<b>8217.12</b>	
	<b>Sealing plugs TL 25 mm</b>	<b>8256.99</b>	
	<b>Endoscope-side adapter</b> for connecting a STORZ light cable to WOLF endoscopes	<b>8088.00</b>	
	<b>Container</b> (W x H x D): 500 x 60 x 200 mm	<b>33024</b>	
	<b>Perforated basket for small parts</b> (W x H x D): 128 x 35 x 121 mm	<b>33006</b>	

# BRONCHOSCOPE / TRACHEOSCOPE TUBE TEXAS MODEL

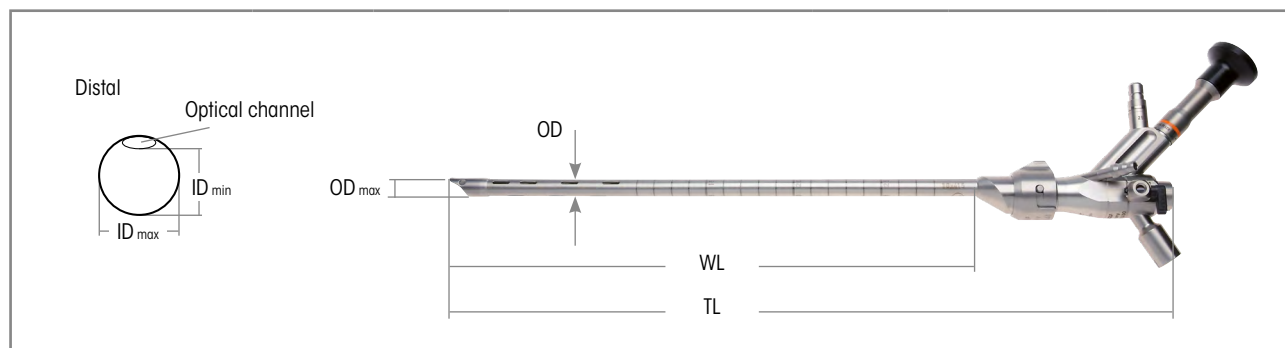

TEXAS	minimal inner Ø (ID min)	maximal inner Ø (ID max)	Insertion part outer Ø (OD max)	Sheath outer Ø (OD)	WL	TL (with adapted telescope element)	Product no.
Bronchoscope tube ID 9.2 mm	6 mm	9,2 mm	11,4 mm	10 mm	305 mm	415 mm	<b>82520.0641</b>
Bronchoscope tube ID 11 mm	8 mm	11 mm	13,2 mm	12 mm	310 mm	415 mm	<b>82520.0841</b>
Bronchoscope tube ID 11 mm * without distal viewing window	8 mm	11 mm	13,2 mm	12 mm	310 mm	415 mm	<b>82520.0842*</b>
Bronchoscope tube ID 13 mm	10 mm	13 mm	15,2 mm	14 mm	318 mm	420 mm	<b>82520.1041</b>
Tracheoscope tube ID 15 mm	12 mm	15 mm	17,2 mm	16 mm	325 mm	420 mm	<b>82520.1241</b>
Tracheoscope tube ID 17.1 mm	14 mm	17,1 mm	19,3 mm	18 mm	330 mm	425 mm	<b>82520.1441</b>



Tracheoscope tube ID 11 mm	8 mm	11 mm	13,2 mm	12 mm	295,5 mm	405 mm	<b>825210830</b>
Tracheoscope tube ID 13 mm	10 mm	13 mm	15,2 mm	14 mm	300 mm	405 mm	<b>825211030</b>
Tracheoscope tube ID 15 mm	12 mm	15 mm	17,2 mm	16 mm	300 mm	403 mm	<b>825211230</b>
Tracheoscope tube ID 17 mm	14 mm	17 mm	19,3 mm	18 mm	300 mm	403 mm	<b>825211430</b>

# ENDOBRONCHIAL SHAVER BLADES

## FOR GENTLE AND SAFE TISSUE RESECTION AND MUCUS REMOVAL



**MOTOR CONTROL UNIT 2304**

Power supply connection 50/60 Hz, 230 V  
 Includes power supply cable, CAN bus connection cable,  
 and packaging ..... **2304.001**

For connecting the motor handpieces M4, M5/0, M5/3, S1, and M1,  
 connection option for 2 handpieces and one footswitch, compatible with  
 core, dimensions (W x H x D): 330 x 155 x 365 mm

Recommended accessories		Product no.
Footswitch, 2 pedals		<b>2304.901</b>

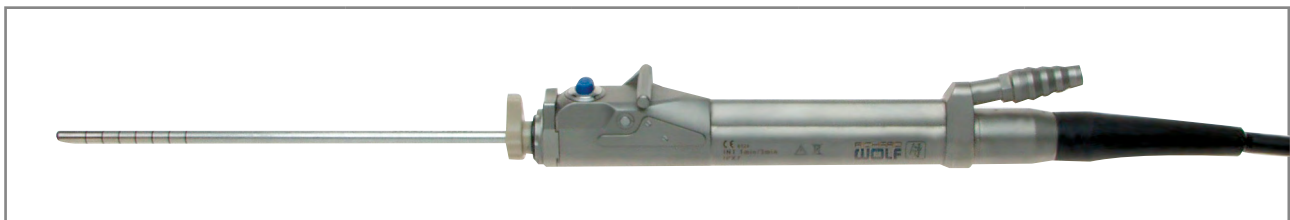

For driving rotation tools with one function button			Ø for shaver tools	Product no.
Motor handpiece max. 3,000 rpm	with fixed connection cable, 3.0 m	Operation via ON/OFF button	2–3.5 mm	<b>89951.0001</b>

V125 || Subject to modifications. Please note that some products may not be available in all countries. Please always take note of the information that is provided with the product. For more detailed information, please consult with your contact partner or directly with Richard Wolf GmbH.

## ENDOBONCHIAL SHAVER BLADES

FOR GENTLE AND SAFE TISSUE RESECTION AND MUCUS REMOVAL

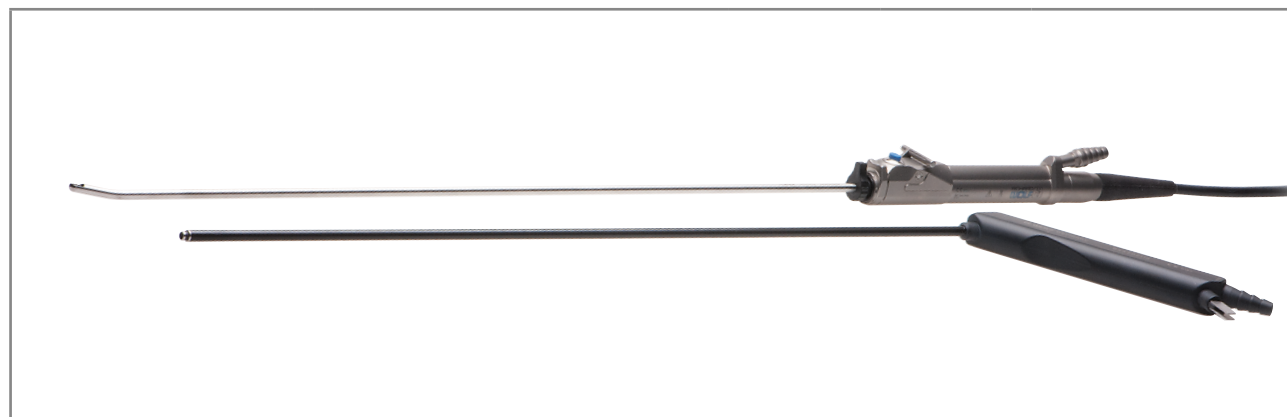



	Reusable (1 pc)	WL	Ø	Product no.
	Resector, curved Ø 4.5 mm WL 460 mm	460 mm	4.5 mm	<b>825620446</b>
	Resector, curved, smooth Ø 4.5 mm WL 460 mm		4.5 mm	<b>825610446</b>
	Resector, aggressive Ø 5.5 mm WL 460 mm		5.5 mm	<b>825630546</b>
	Secretion remover Ø 5.5 mm WL 448 mm		5.5 mm	<b>825640546</b>
	HF coagulation suction tube OD 5.2 mm WL 460 mm		5.2 mm	<b>844202110</b>

Recommended accessories	Product no.
<b>Optic element bundle</b> Endoscope with fiber image guide, TEXAS model, DOV 12°, with integrated lens irrigation and protective sheath	<b>82510.1400</b>
<b>Tracheoscope tube ID 11 mm</b> for telescope element 82510.1400, OD 13.2 mm, WL 295.5 mm	<b>825210830</b>
<b>Tracheoscope tube ID 13 mm</b> for telescope element 82510.1400, OD 15.2 mm, WL 299 mm	<b>825211030</b>

# ARTICULATED FORCEPS FOR RIGID BRONCHOSCOPY TIPCONTROL



TipControl	Outer Ø	WL	TL	Product no.
<b>Biopsy forceps Ø 5.2 mm</b> <b>483 mm</b> 	5.2 mm	483 mm	645 mm	<b>823400001</b>
<b>Grasping forceps Ø 5.2 mm</b> <b>485 mm</b> 	5.2 mm	485 mm	647 mm	<b>823400002</b>
<b>Scissors Ø 5.2 mm</b> <b>482 mm</b> 	5.2 mm	482 mm	644 mm	<b>823400003</b>

Optional accessories	Product no.
Luer sealing cap	<b>15023205</b>



**BIPOLAR FORCEPS FOR EXCISIONAL BIOPSY**  
FOR RIGID BRONCHOSCOPY

**ERAGON** bipolar



ERAGONBIPOLAR FORCEPS

1.3

Jaw insert		Sheath tube Ø 5.5 mm SL 435 mm	Handle, pistol-shaped, bipo	Complete instrument • Jaw insert with sheath tube • Handle
		SL 435 mm	 rotatable	
Product no.		82340024	839300102	Product no.
Bipolar forceps bndl Ø 5.5 mm 		82340014	•	•
				<b>823400005</b>

Optional accessories	
Bipolar connection cable	See THORAX109/110

# BRONCHOSCOPE TUBE

## WOLF model

### with distal illumination

BRONCHOSCOPE / TRACHEOSCOPE TUBE

1.4

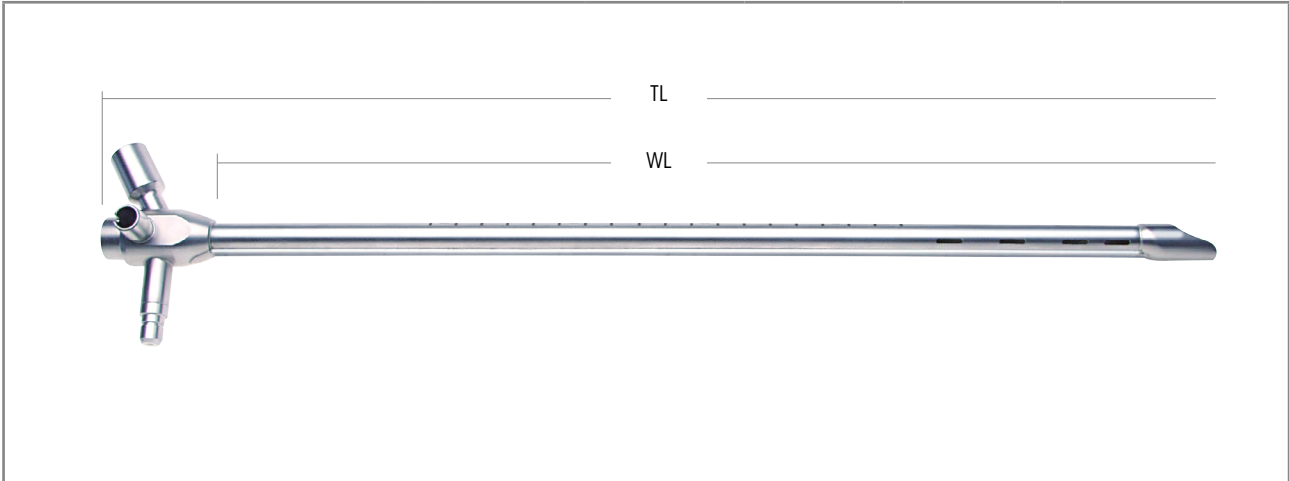

with fixed distal light carrier	Inner Ø	Outer Ø	WL	TL	Product no.	
<b>Bronchoscope tube bndl</b> consisting of: Bronchoscope tube ID 7.5 mm (8214.072) and sealing cap (8205.13*)	7.5 mm	8.5 mm		400 mm	<b>8214.0721</b>	
<b>Bronchoscope tube bndl</b> consisting of: Bronchoscope tube ID 8.5 mm (8214.082) and sealing cap (8205.13*)	8.5 mm	9.5 mm		357 mm	400 mm	<b>8214.0821</b>
<b>Bronchoscope tube bndl</b> consisting of: Bronchoscope tube ID 7.5 mm (8214.092) and sealing cap (8205.13*)	9.5 mm	8.5 mm		400 mm	<b>8214.0921</b>	
<b>Bronchoscope tube bndl</b> consisting of: Bronchoscope tube ID 10.5 mm (8214.102) and sealing cap (8205.13*)	10.5 mm	11.5 mm	387 mm	430 mm	<b>8214.1021</b>	

\* for the lateral respiration nozzle.

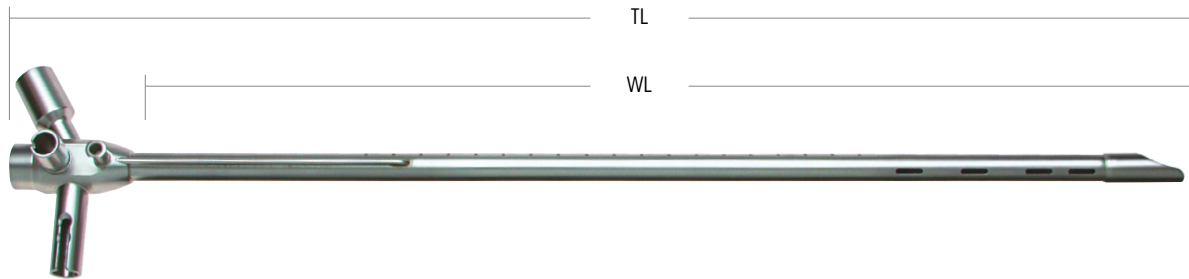

Matching adapter for telescope			
<b>Matching bronchoscope tube bndl</b>	8214.1021	8214.0721 8214.0821 8214.0921	
<b>Matching telescope 0° Ø 5.5 mm WL 488 mm</b>	8465.30	8465.30 8465.30	
<b>Adapter for telescope TL 94 mm</b>	<b>8215.714</b>		
<b>Adapter for telescope TL 124 mm</b>		<b>8215.715</b>	

# BRONCHOSCOPE TUBE HEMER MODEL

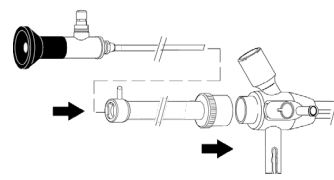

with proximal illumination and sampling channel, graduated	Inner Ø	Outer Ø	WL	TL	Product no.
<b>Bronchoscope tube bndl</b> consisting of: Bronchoscope tube ID 6.5 mm (8214.064), Luer sealing cap (15023205), sealing cap (8205.13*), and sealing plug TL 25 mm (8256.99)	6.5 mm	7.5 mm	357 mm	400 mm	<b>8214.0641</b>
<b>Bronchoscope tube bndl</b> consisting of: Bronchoscope tube ID 7.5 mm (8214.074), Luer sealing cap (15023205), sealing cap (8205.13*), and sealing plug TL 25 mm (8256.99)	7.5 mm	8.5 mm			<b>8214.0741</b>
<b>Bronchoscope tube bndl</b> consisting of: Bronchoscope tube ID 8.5 mm (8214.084), Luer sealing cap (15023205), sealing cap (8205.13*), and sealing plug TL 25 mm (8256.99)	8.5 mm	9.5 mm	387 mm	430 mm	<b>8214.0841</b>
<b>Bronchoscope tube bndl</b> consisting of: Bronchoscope tube ID 9.5 mm (8214.094), Luer sealing cap (15023205), sealing cap (8205.13*), and sealing plug TL 25 mm (8256.99)	9.5 mm	10.5 mm			<b>8214.0941</b>
<b>Bronchoscope tube bndl</b> consisting of: Bronchoscope tube ID 10.5 mm (8214.104), Luer sealing cap (15023205), sealing cap (8205.13*), and sealing plug TL 25 mm (8256.99)	10.5 mm	11.5 mm			<b>8214.1041</b>
<b>Bronchoscope tube bndl</b> consisting of: Bronchoscope tube ID 12 mm (8214.126), Luer sealing cap (15023205), sealing cap (8205.13*), and sealing plug TL 25 mm (8256.99)	12.0 mm	13.0 mm			<b>8214.1261</b>

\* for the lateral respiration nozzle.

Matching adapter for telescope				
<b>Matching Bronchoscope tube bndl</b>	8214.0841 8214.0941 8214.1041 8214.1261	8214.0641 8214.0741	8214.1241	
<b>Matching telescope 0° Ø 5.5 mm WL 488 mm</b>	8465.30	8465.30	8465.30	
<b>Adapter for telescope TL 94 mm</b>	<b>8215.714</b>			
<b>Adapter for telescope TL 124 mm</b>		<b>8215.715</b>		
<b>Adapter for telescope TL 174 mm</b>			<b>8215.716</b>	

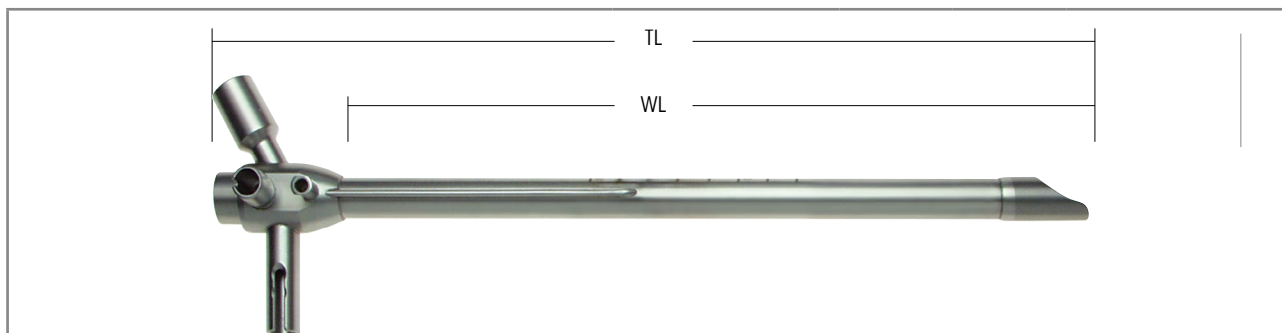

V125 | Subject to modifications. Please note that some products may not be available in all countries. Please always take note of the information that is provided with the product. For more detailed information, please consult with your contact partner or directly with Richard Wolf GmbH.

# TRACHEOSCOPE TUBE HEMER MODEL





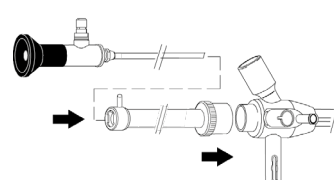





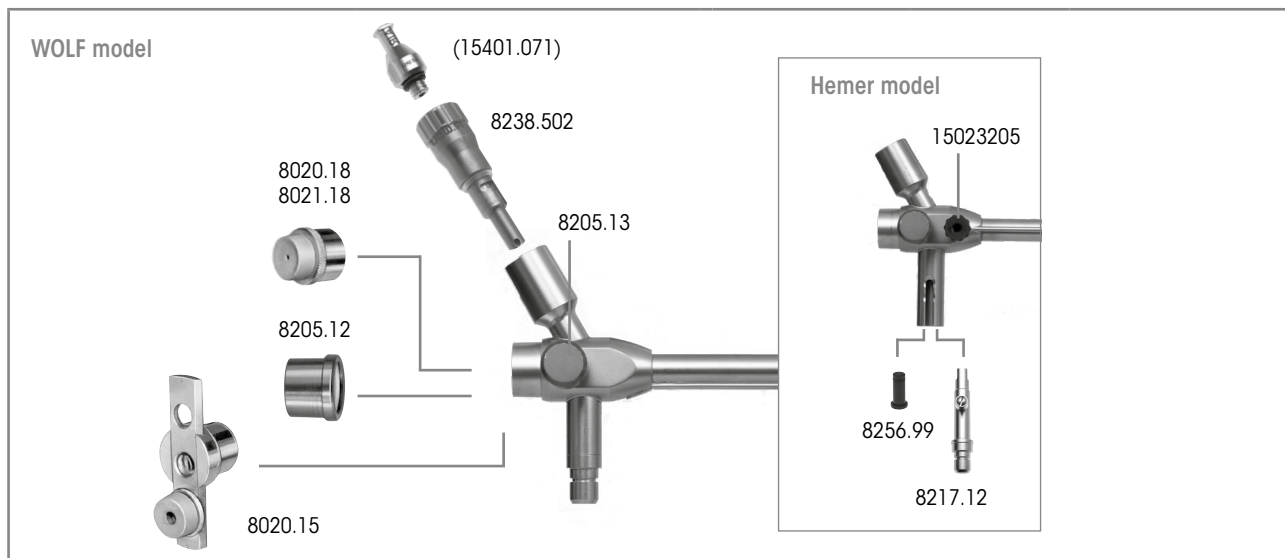





with proximal illumination and sampling channel, graduated	Inner Ø	Outer Ø	WL	TL	Product no.
<b>Tracheoscope tube bndl</b> consisting of: Tracheoscope tube ID 12 mm (8214.124) Luer sealing cap (15023205), sealing cap (8205.13*), and sealing plug TL 25 mm (8256.99)	12 mm	13 mm	307 mm	350 mm	<b>8214.1241</b>
<b>Tracheoscope tube bndl</b> consisting of: Tracheoscope tube ID 12 m (8214.128), Luer sealing cap (15023205), sealing cap (8205.13*), and sealing plug TL 25 mm (8256.99)	12 mm	13 mm	257 mm	300 mm	<b>8214.1281</b>
<b>Tracheoscope tube bndl</b> consisting of: Tracheoscope tube ID 14 mm (8214.144), Luer sealing cap (15023205), sealing cap (8205.13*), and sealing plug TL 25 mm (8256.99)	14 mm	15 mm		300 mm	<b>8214.1441</b>

\* for the lateral respiration nozzle.

Matching adapter for telescope		
<b>Matching tracheoscope tube bndl</b>	8214.1281 8214.1441	
<b>Matching telescope 0° Ø 5.5 mm WL 488 mm</b>	8465.30	
<b>Adapter for telescope TL 211 mm</b>	<b>8215.713</b>	

# WOLF MODEL BRONCHOSCOPE TUBE HEMER MODEL BRONCHOSCOPE / TRACHEOSCOPE TUBE ACCESSORIES AND AUXILIARY INSTRUMENTS



Recommended accessories		Product no.	
	<b>Sealing cap</b> with monitoring window	<b>8205.12</b>	
	<b>Sealing cap</b> (blue)	<b>8205.13</b>	
	<b>Luer sealing cap</b>	<b>15023205</b>	
	<b>Sealing cap for bronchoscope</b> with telescope sealing cap for telescopes Ø 5.5 mm	<b>8020.18</b>	
	<b>Sealing cap for bronchoscope</b> with telescope sealing cap for telescopes Ø 4 mm, 3.4 mm, and 2.7 mm	<b>8021.18</b>	
	<b>Universal cap for bronch.</b>	<b>8020.15</b>	
	<b>Spare telescope sealing caps</b> (Pack=10 PCS)		
	for telescopes Ø 5,5 mm	<b>Sealing cap cap 5.1-6.0 mm</b>	<b>89.03</b>
	for telescopes Ø 4 mm	<b>Sealing cap cap 3.4-5.1 mm</b>	<b>89.02</b>
	for telescopes Ø 2,7 mm and 3,4 mm	<b>Sealing cap cap 2.4-3.4 mm</b>	<b>89.01</b>
	<b>Respiration adapter jet ventilation bndl</b> consisting of:	<b>8238.5021</b>	
	Respiration adapter for jet ventilation (8238.502) and Luer connector (15401.071)		
	<b>Illumination insert</b>	<b>8217.12</b>	
	<b>Endoscope-side adapter</b> for connecting a WOLF light cable to WOLF endoscopes (only with models 82514.xxx in connection with 8217.12)	<b>8095.00</b>	
	<b>Sealing plugs TL 25 mm</b>	<b>8256.99</b>	
	(W x H x D) 500 x 60 x 200 mm	<b>33024</b>	
	<b>Perforated basket for small parts</b> (W x H x D): 128 x 35 x 121 mm	<b>33006</b>	

V125 | Subject to modifications. Please note that some products may not be available in all countries. Please always take note of the information that is provided with the product. For more detailed information, please consult with your contact partner or directly with Richard Wolf GmbH.

# PANOVIEW TELESCOPE

Ø 3.4 MM / Ø 4.0 MM / Ø 5.5 MM

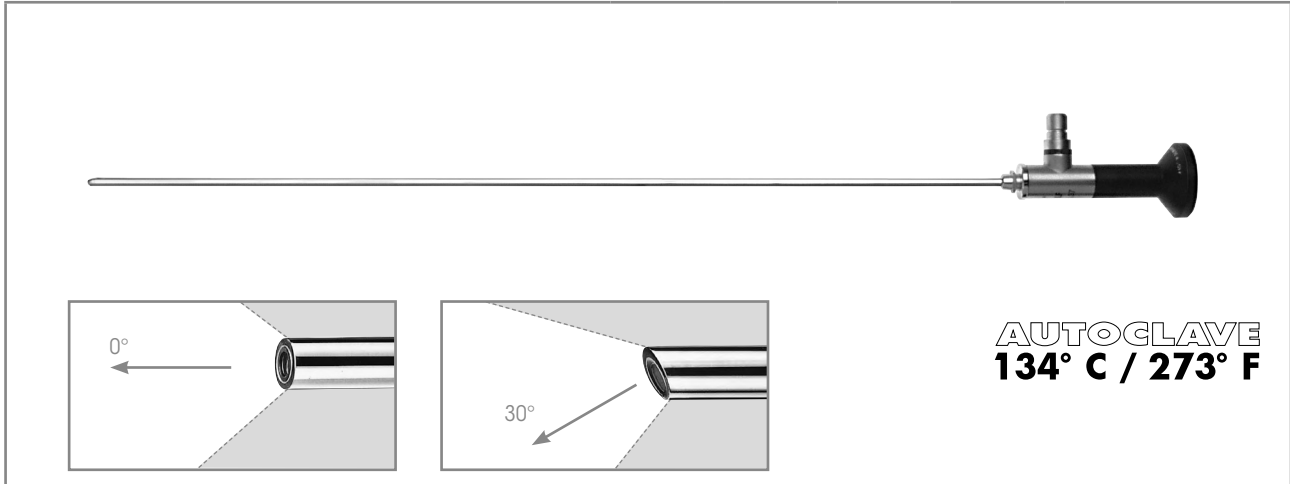

	Direction of view	WL	TL	Ø	Product no.
PANOVIEW Telescope 0° Ø 3.4 mm WL 378 mm	0°	378 mm	457 mm	3.4 mm	<b>8464.30</b>
PANOVIEW PLUS Telescope 0° Ø 4 mm WL 519 mm	0°	519 mm	595 mm	4.0 mm	<b>82514.431</b>
PANOVIEW PLUS Telescope 30° Ø 4 mm WL 519 mm	30°				<b>82514.433</b>
PANOVIEW Telescope 0° Ø 5.5 mm WL 488 mm	0°	488 mm	564 mm	5.5 mm	<b>8465.30</b>
PANOVIEW Telescope 30° Ø 5.5 mm WL 489 mm	30°	489 mm	565 mm		<b>8465.32</b>

Recommended accessories		Product no.
Perforated basket for standard telescope 2	(W x H x D) 481 x 54 x 59 mm	<b>38016</b>
Perforated basket for standard telescope 3	(W x H x D) 619 x 54 x 59 mm	<b>38017</b>
Fiber light cable bndl consisting of: Fiber light cable (80662523), projector-side adapter (8095.07), and endoscope-side adapter (809509)	Ø 2.5 mm, 2.3 m long	<b>806625231</b>





PANOVIEW TELESCOPE  
1.5

V125 || Subject to modifications. Please note that some products may not be available in all countries. Please always take note of the information that is provided with the product. For more detailed information, please consult with your contact partner or directly with Richard Wolf GmbH.

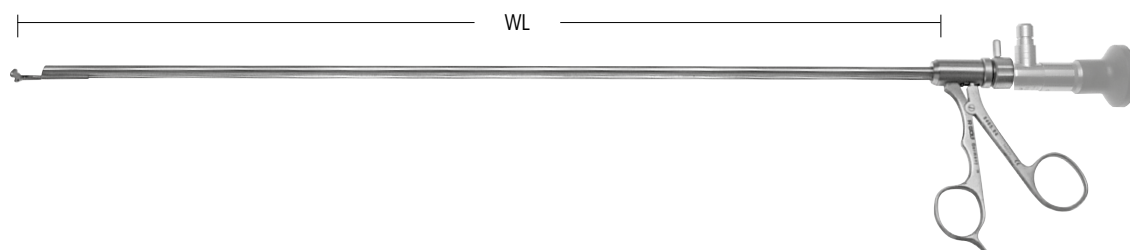
# OPTICAL FORCEPS

FOR BRONCHOSCOPE TUBE AND Ø 3.4 MM TELESCOPE







	WL	Inner Ø	Height	Matching bronchoscope tubes	Matching telescope	Product no.
<b>Pike-mouth grasping forceps</b> <b>Ø 3.5 mm TL 420 mm</b> Jaw section curved upward 	359 mm	3.5 mm	5.5 mm	Hemer model 8214.1241 (ID 12.0) 8241.1281 (ID 12.0) 8214.1441 (ID 14.0)  Pediatric bronchoscope tubes 82510.5530 (ID 5.7) 82514.6030 (ID 6.2) 82510.6035 (ID 6.2) 82510.65351 (ID 6.7) 82514.65351 (ID 6.7)	8464.30	<b>8464.61</b>
<b>Biopsy forceps</b> <b>Ø 3.5 mm TL 420 mm</b> with double spoon jaw 	359 mm	3.5 mm	5.5 mm			<b>8464.63</b>
<b>Biopsy forceps</b> <b>Ø 3.5 mm TL 420 mm</b> with retrograde spoon jaw 	359 mm	3.5 mm	5.5 mm			<b>8464.64</b>
<b>Opt. grasping forceps WL</b> <b>358 mm</b> Straight jaw section 	358 mm	3.4 mm	5.4 mm			<b>82530.0404</b>
for soft foreign bodies <b>Opt. universal forceps</b> <b>WL 358 mm</b> Jaw section curved upward 	358 mm	3.4 mm	5.4 mm			<b>82530.0405</b>

VI25 || Subject to modifications. Please note that some products may not be available in all countries. Please always take note of the information that is provided with the product. For more detailed information, please consult with your contact partner or directly with Richard Wolf GmbH.

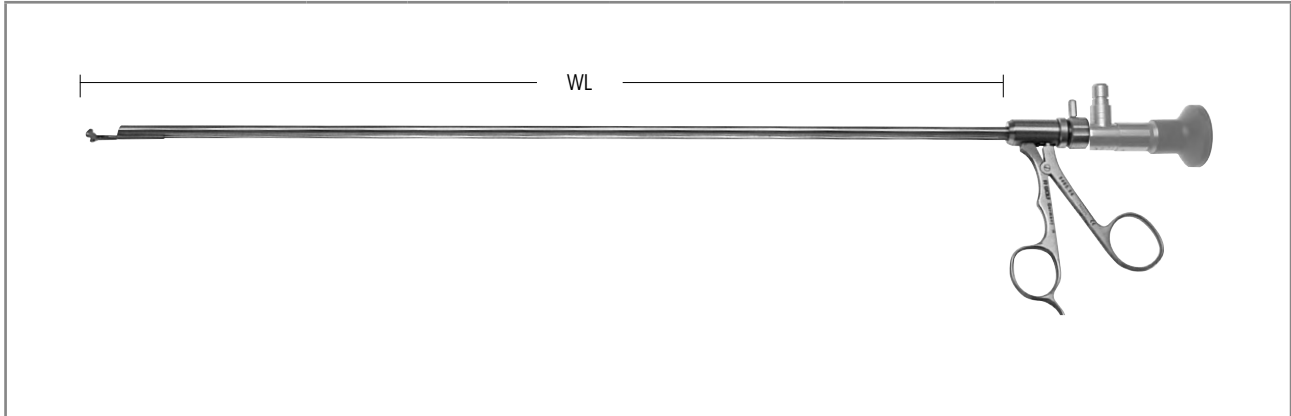
# OPTICAL FORCEPS

FOR BRONCHOSCOPE TUBE AND Ø 4.0 MM TELESCOPE







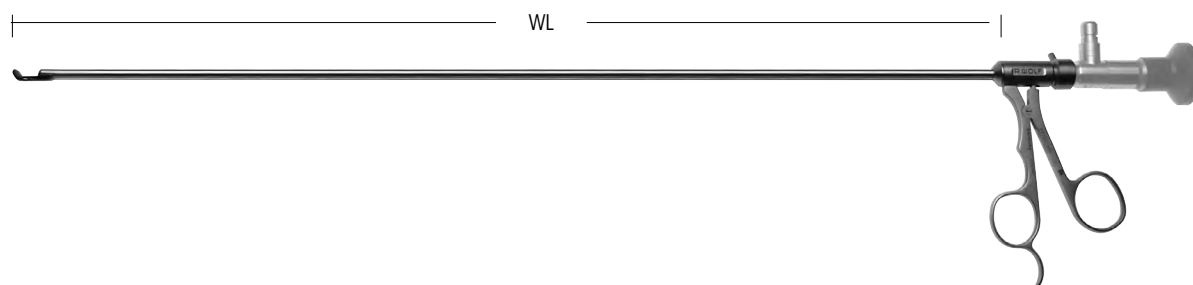

	WL	Inner Ø	Height	Matching bronchoscope tubes	Matching telescope	Product no.
<b>Opt. grasping forceps</b> <b>WL 473 mm</b> Jaw section curved upward 	473 mm	5.6 mm	8.4 mm	Hemer model 8214.0841 (ID 8.5) 8214.0941 (ID 9.5) 8214.1041 (ID 10.5) 8214.1241 (ID 12.0) 8214.1261 (ID 12.0) 8241.1281 (ID 12.0) 8214.1441 (ID 14.0)	8465.30	<b>8465.61</b>
<b>Opt. biopsy forceps</b> <b>WL 472 mm</b> Straight jaw section 	472 mm	5.6 mm	8.4 mm	Wolf model 8214.0821 (ID 8.5) 8214.0921 (ID 9.5) 8214.1021 (ID 10.5)		<b>8465.63</b>
<b>Opt. biopsy forceps</b> <b>WL 473 mm</b> Jaw section retrograde 	473 mm	5.6 mm	8.4 mm			<b>8465.64</b>

V125 || Subject to modifications. Please note that some products may not be available in all countries. Please always take note of the information that is provided with the product. For more detailed information, please consult with your contact partner or directly with Richard Wolf GmbH.

# OPTICAL FORCEPS

FOR BRONCHOSCOPE TUBE AND Ø 4.0 MM TELESCOPE







	WL	Inner Ø	Height	Matching bronchoscope tubes	Matching telescope	Product no.
<b>Opt. biopsy forceps</b> <b>WL 500 mm</b> Jaw section curved upward 	500 mm	4.1 mm	6.4 mm	Hemer model 8214.0641 (ID 6.5) 8214.0741 (ID 7.5) 8214.0841 (ID 8.5) 8214.0941 (ID 9.5) 8214.1041 (ID 10.5) 8214.1241 (ID 12.0) 8214.1261 (ID 12.0) 8241.1281 (ID 12.0) 8214.1441 (ID 14.0)  Wolf model 8214.0721 (ID 7.5) 8214.0821 (ID 8.5) 8214.0921 (ID 9.5) 8214.1021 (ID 10.5)  Pediatric bronchoscope tubes 82510.65351 (ID 6.7) 82514.65351 (ID 6.7)	82514.431	<b>82530.0701</b>
<b>Opt. biopsy forceps</b> <b>WL 498 mm</b> Jaw section retrograde and curved upward 	498 mm	4.1 mm	6.4 mm			<b>82530.0702</b>
<b>Opt. grasping forceps</b> <b>WL 500 mm</b> Jaw section curved upward 	500 mm	4.1 mm	6.4 mm			<b>82530.0703</b>
<b>Opt. grasping forceps</b> <b>WL 504 mm</b> Straight jaw section 	504 mm	4.1 mm	6.4 mm			<b>82530.0704</b>
<b>Opt. grasping forceps</b> <b>WL 500 mm</b> Jaw section curved upward 	500 mm	4.1 mm	6.4 mm			<b>82530.0705</b>

V125 || Subject to modifications. Please note that some products may not be available in all countries. Please always take note of the information that is provided with the product. For more detailed information, please consult with your contact partner or directly with Richard Wolf GmbH.

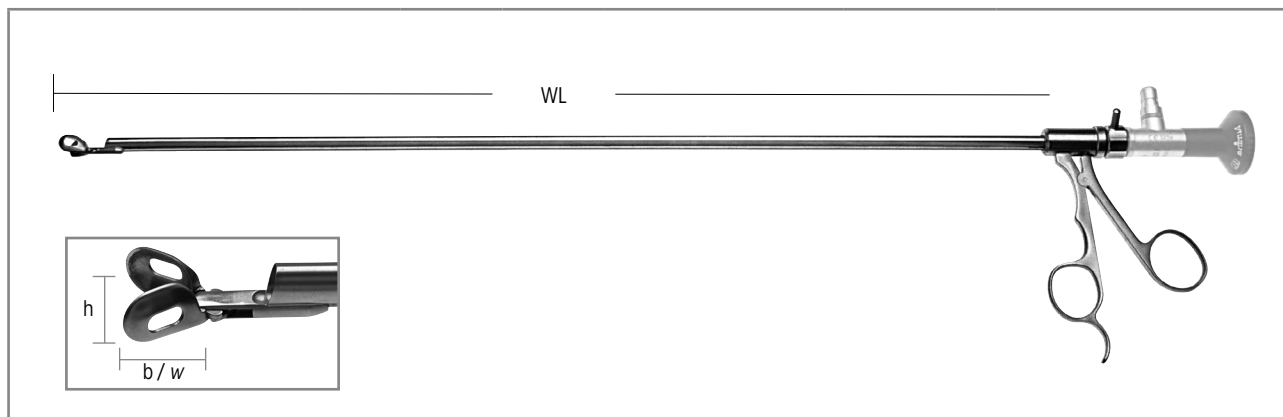
# OPTICAL FORCEPS

## FOR BRONCHOSCOPE TUBE AND Ø 5.5 MM TELESCOPE





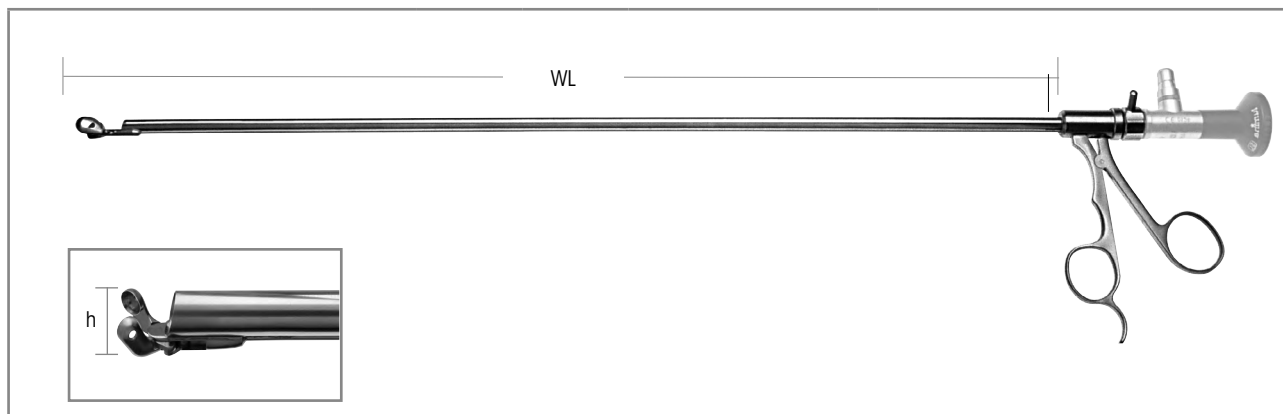

	WL	Inner Ø	Height	Matching bronchoscope tubes	Matching telescope	Product no.
<b>Opt. biopsy forceps</b> <b>WL 474 mm</b> Reichle, straight jaw section Bagger XL 	474 mm	5.6 mm	8.5 mm	Hemer model 8214.0941 (ID 9.5) 8214.1041 (ID 10.5) 8214.1241 (ID 12.0) 8214.1261 (ID 12.0) 8241.1281 (ID 12.0) 8214.1441 (ID 14.0)  Wolf model 8214.0921 (ID 9.5) 8214.1021 (ID 10.5)	8465.30	<b>8466.651</b>
<b>Opt. biopsy forceps</b> <b>WL 478 mm</b> Reichle, straight jaw section Bagger XXL 	478 mm	5.6 mm	9.0 mm			<b>8466.652</b>
<b>Opt. grasping forceps</b> <b>WL 479 mm</b> Reichle, straight jaw section Grasper XXL 	479 mm	4.1 mm	8.4 mm			<b>8466.653</b>
<b>Opt. grasping forceps</b> <b>WL 482 mm</b> Straight jaw section Grasper 3XL 	482 mm	5.7 mm	∅ 10.5 mm			Hemer model 8214.1241 (ID 12.0) 8214.1261 (ID 12.0) 8241.1281 (ID 12.0) 8214.1441 (ID 14.0)

# OPTICAL FORCEPS

FOR BRONCHOSCOPE TUBE AND Ø 5.5 MM TELESCOPE







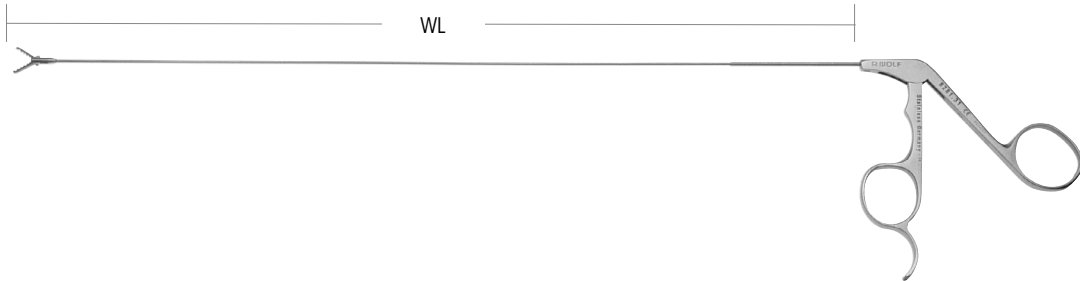

	WL	Inner Ø	Height	Matching bronchoscope tubes	Matching telescope	Product no.
<b>Opt. biopsy forceps</b> <b>WL 462 mm</b> Jaw section curved upward 	462 mm	5.6 mm	8.4 mm			<b>82530.0601</b>
<b>Opt. biopsy forceps</b> <b>WL 462 mm</b> Jaw section retrograde and curved upward 	462 mm	5.6 mm	8.4 mm	Hemer model 8214.0841 (ID 8.5) 8214.0941 (ID 9.5) 8214.1041 (ID 10.5) 8214.1241 (ID 12.0) 8214.1261 (ID 12.0) 8241.1281 (ID 12.0) 8214.1441 (ID 14.0)	8465.30	<b>82530.0602</b>
<b>Opt. grasping forceps</b> <b>WL 469 mm</b> Straight jaw section  for soft foreign bodies	469 mm	5.6 mm	8.4 mm	Wolf model 8214.0821 (ID 8.5) 8214.0921 (ID 9.5) 8214.1021 (ID 10.5)		<b>82530.0604</b>
<b>Opt. universal forceps</b> <b>WL 464 mm</b> Jaw section curved upward 	464 mm	5.6 mm	8.4 mm			<b>82530.0605</b>

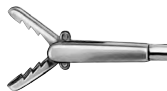
V125 || Subject to modifications. Please note that some products may not be available in all countries. Please always take note of the information that is provided with the product. For more detailed information, please consult with your contact partner or directly with Richard Wolf GmbH.



# BRONCHOSCOPE FORCEPS





For bronchoscope tubes with inner Ø		≥ 6 mm	4 mm	≤ 4 mm	Product no.
	<b>Grasping forceps WL 465 mm</b> serrated	•			<b>8280.41</b>
	<b>Foreign body grasping forceps Ø 3 mm</b> serrated, TL 450 mm		•		<b>8281.311</b>
	<b>Universal forceps WL 465 mm</b> serrated	•			<b>8280.42</b>
	<b>Biopsy forceps WL 460 mm</b> smooth	•			<b>8280.43</b>
	<b>Biopsy forceps WL 335 mm</b> smooth			•	<b>8282.33</b>
	<b>Spoon forceps WL 460 mm</b> smooth	•			<b>8280.44</b>
	<b>Tumor forceps WL 460 mm</b> severing	•			<b>8280.45</b>
	<b>Rotation forceps WL 465 mm</b> for hard foreign bodies	•			<b>8280.46</b>
	<b>Grasping forceps WL 465 mm</b> rippled, for soft foreign bodies	•			<b>8280.47</b>
	<b>Grasping forceps WL 365 mm</b> rippled, for soft foreign bodies		•		<b>8281.37</b>
	<b>Grasping forceps WL 330 mm</b> rippled, for soft foreign bodies			•	<b>8282.37</b>
	<b>Biopsy forceps WL 360 mm</b>			•	<b>8281.33</b>

## AUXILIARY INSTRUMENTS

### ACCESSORIES FOR SUCTION AND IRRIGATION

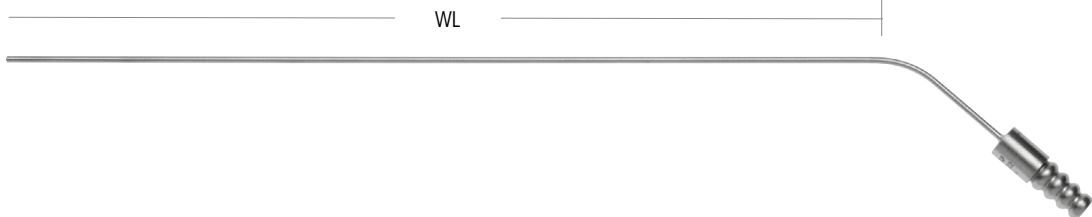
		Ø	WL	Product no.
	<b>Cotton swabs</b> Ø 3.0 mm WL 350 mm	3.0 mm	350 mm	<b>8295.35</b>
	<b>Cotton swabs</b> Ø 3.0 mm WL 500 mm		500 mm	<b>8295.50</b>
	<b>Cotton applicator</b> Ø 3.4 mm WL 490 mm	3.4 mm	490 mm	<b>8296.51</b>

		Outer Ø	WL	Product no.
				
<b>For suction and irrigation</b>		<b>Outer Ø</b>	<b>WL</b>	<b>Product no.</b>
	<b>Suction tube OD 4 mm WL 500 mm</b> central, lateral openings, rigid	4.0 mm	500 mm	<b>8291.45</b>

		Outer Ø	TL	Product no.
	<b>Hand blower</b> with disposable filter, sterile (PACK = 5 PCS)	49 mm	567 mm	<b>412700</b>

VI25 || Subject to modifications. Please note that some products may not be available in all countries. Please always take note of the information that is provided with the product. For more detailed information, please consult with your contact partner or directly with Richard Wolf GmbH.